

Junction Box

LTB02-B

Suitable for CMT24XX Series



Properties	
Parameter	Junction box for CMT24XX series
Construction	Aluminum alloy
Dimension	Φ96.8×33.5mm(Φ3.8"×1.3")
Weight	180g(0.4lbs)

Dimensions:

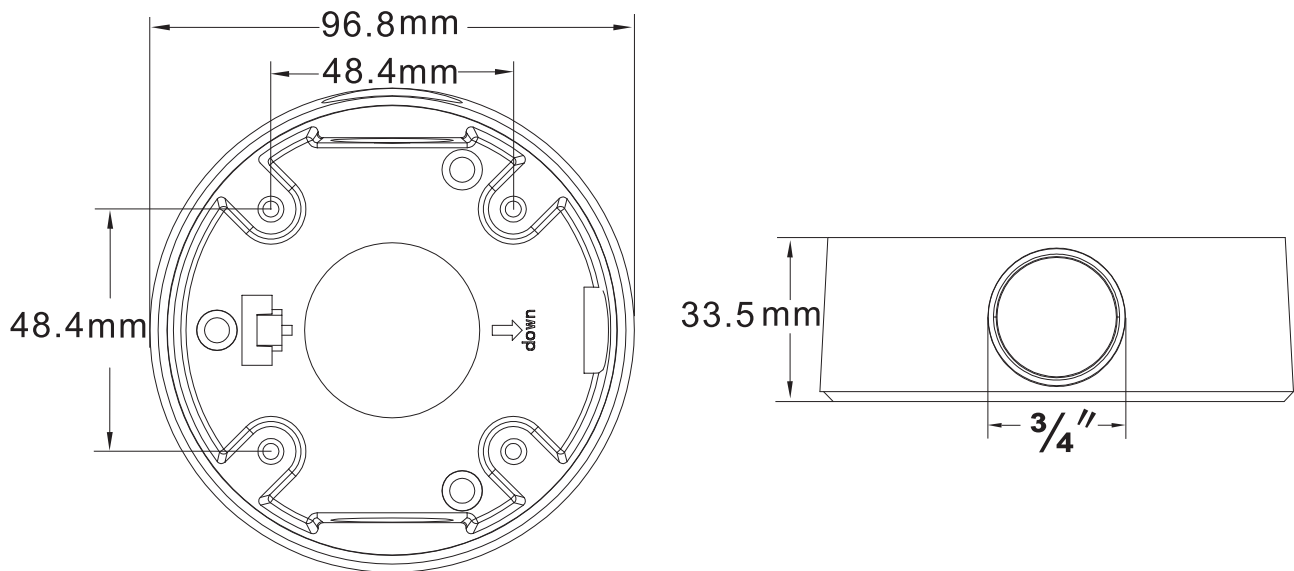

©2015 LT Security, Inc. All Rights Reserved. White papers, data sheets, quick start guides, and/or user manuals are for reference only and may or may not be entirely up to date or accurate based upon the version or models. Product names mentioned herein may be the unregistered and/or registered trademarks of their respective owners.