

Network Video Recorder

Quick Start Guide

TABLE OF CONTENTS

NVR Pre-Installation	3
NVR Installation	3
Hard Disk Installation	3
Front Panel	6
Rear Panel	
Peripheral Connections	8
Wiring of Alarm Input	8
Wiring of Alarm Output	8
Using of Alarm Connectors.....	8
Controller Connection.....	9
Specifications	10
HDD Storage Calculation Chart	11
Accessing by Web Browser	12
Logging In	12
Live View	12
Recording	13
Playback	15
Log	16
Menu Operation	17
Menu Structure	17
Startup and Shutdown	17
Live View	17
Adding IP Cameras	18
One-touch RAID Configuration.....	19
Recording	20
Instant Recording	20
All-day Recording	21
Playback	21
Backup.....	22

Regulatory information

FCC information

FCC compliance: This equipment has been tested and found to comply with the limits for a digital device, pursuant to part 15 of the FCC Rules. These limits are designed to provide reasonable protection against harmful interference when the equipment is operated in a commercial environment. This equipment generates, uses, and can radiate radio frequency energy and, if not installed and used in accordance with the instruction manual, may cause harmful interference to radio communications. Operation of this equipment in a residential area is likely to cause harmful interference in which case the user will be required to correct the interference at his own expense.

FCC conditions

This device complies with part 15 of the FCC Rules. Operation is subject to the following two conditions:

1. This device may not cause harmful interference.
2. This device must accept any interference received, including interference that may cause undesired operation.

EU Conformity Statement



This product and - if applicable - the supplied accessories too are marked with "CE" and comply therefore with the applicable harmonized European standards listed under the Low Voltage Directive 2006/95/EC, the EMC Directive 2004/108/EC, the RoHS Directive 2011/65/EU.



2012/19/EU (WEEE directive): Products marked with this symbol cannot be disposed of as unsorted municipal waste in the European Union. For proper recycling, return this product to your local supplier upon the purchase of equivalent new equipment, or dispose of it at designated collection points. For more information see:

www.recyclethis.info.



2006/66/EC (battery directive): This product contains a battery that cannot be disposed of as unsorted municipal waste in the European Union. See the product documentation for specific battery information. The battery is marked with this symbol, which may include lettering to indicate cadmium (Cd), lead (Pb), or mercury (Hg). For proper recycling, return the battery to your supplier or to a designated collection point. For more information see:

www.recyclethis.info.

Trademarks and Registered Trademarks

- Windows and Windows mark are trademarks or registered trademarks of Microsoft Corporation in the United States and/or other countries.
- HDMI, HDMI mark and High-Definition Multimedia Interface are trademarks or registered trademarks of HDMI Licensing LLC.
- The products contained in this manual are authorized by HDMI Licensing LLC with the use right of the HDMI technology.



- VGA is the trademark of IBM.
- UPnP™ is a certification mark of the UPnP™ Implementers Corporation.
- Other names of companies and product contained in this manual may be trademarks or registered trademarks of their respective owners.

Thank you for purchasing our product. If there is any question or request, please do not hesitate to contact dealer.

This manual is applicable to the models listed in the following table.

Series	Model	Type
LTN07XX-R8	LTN0732-R8 LTN0764-R8	Network Video Recorder

NVR Pre-Installation

The NVR is highly advanced surveillance equipment that should be installed with care. Please take into consideration the following precautionary steps before installation of the NVR.

1. Keep all liquids away from the NVR.
2. Install the NVR in a well-ventilated and dust-free area.
3. Ensure environmental conditions meet factory specifications.
4. Install a manufacturer recommended HDD.

NVR Installation

During the installation of the NVR:

1. Use brackets for rack mounting.
2. Ensure there is ample room for audio and video cables.
3. When routing cables, ensure that the bend radius of the cables are no less than five times than its diameter.
4. Connect the alarm cable.
5. Allow at least 2cm (≈0.75-inch) of space between racks mounted devices.
6. Ensure the NVR is grounded.
7. Environmental temperature should be within the range of -10 °C ~ 55 °C, 14°F ~ 131°F.
8. Environmental humidity should be within the range of 10% ~ 90%.

Hard Disk Installation

Before you start:

Disconnect the power from the NVR before installing a hard disk drive (HDD). A factory recommended HDD should be used for this installation.

Tools Required: Screwdriver.

Steps:

1. Fasten the hard disk mounting handle to the hard disk with screws.



2. Insert the key and turn in clockwise direction to open the panel lock.



3. Press the buttons on the panel of two sides and open the front panel.



4. Insert the hard disk along the slot until it is placed into position.

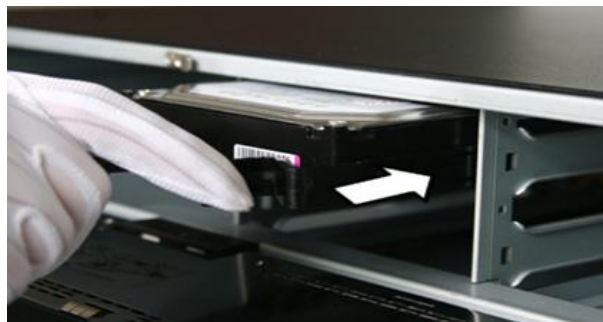

5. Repeat the above steps to install other hard disks onto the NVR. After having finished the installation of all hard disks, close the front panel and lock it with the key again.



Front Panel

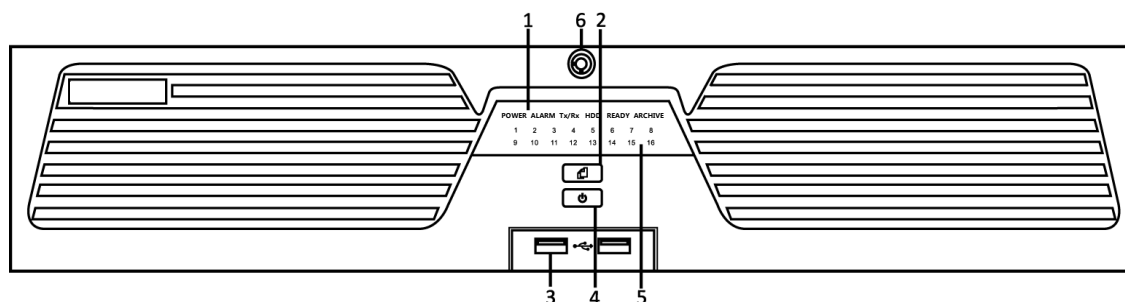

No.	Name	Description	
1	Status LED Indicators	Power	Turning red indicates power is connected but the system isn't running; turning blue indicates power is connected and the system is running.
		Alarm	Alarm LED turns red when a sensor alarm is detected.
		TX/RX	TX/RX LED flashes blue when network connection is functioning properly.
		HDD	HDD LED flashes red when data is being read from or written to HDD.
		Ready	Ready LED turns blue when NVR is functioning properly.
		Archive	Archive LED flashes blue when data is being backed up.
2	Backup Button	Back up video files.	
3	USB Ports	Universal Serial Bus (USB) ports for additional devices such as USB mouse and USB Hard Disk Drive (HDD).	
4	Power Button	Powers NVR on/off.	
5	Channel Status Indicators	Blue indicates recording, red indicates network connection, and purple indicates recording and network connection.	
6	Front Panel Lock	You can lock or unlock the panel by the key.	

Rear Panel

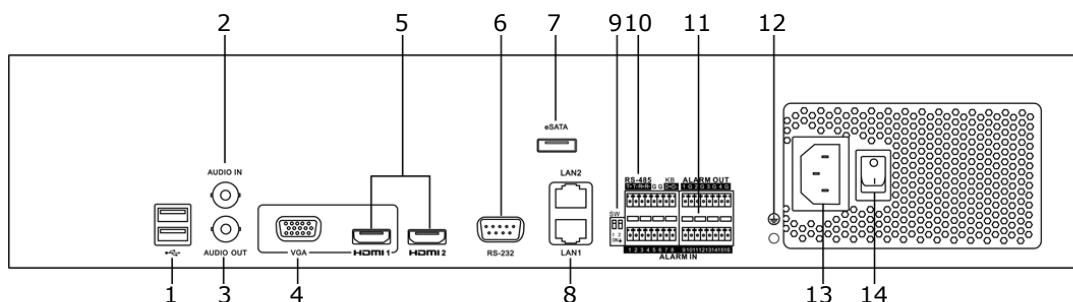

No.	Item	Description
1	USB interface	Universal Serial Bus (USB) ports for additional devices such as USB mouse and USB Hard Disk Drive (HDD).
2	AUDIO IN	RCA connector for audio input.
3	AUDIO OUT	RCA connector for audio output.
4	VGA	DB9 connector for VGA output. Display local video output and menu.
5	HDMI1/HDMI2	HDMI/HDMI2 video output connectors.
6	RS-232 Interface	Connector for RS-232 devices.
7	eSATA	Connects external SATA HDD, CD/DVD-RW.
8	LAN Interface	2 RJ-45 10 /100 /1000 Mbps self-adaptive Ethernet interfaces.
9	Termination Switch	RS-485 termination switch. Up position is not terminated. Down position is terminated with 120Ω resistance.
10	RS-485 Interface	Connector for RS-485 devices. T+ and T- pins connect to R+ and R- pins of PTZ receiver respectively.
	Controller Port	D+, D- pin connects to Ta, Tb pin of controller. For cascading devices, the first NVR's D+, D- pin should be connected with the D+, D- pin of the next NVR.
11	ALARM IN	Connector for alarm input.
	ALARM OUT	Connector for alarm output.
12	GROUND	Ground (needs to be connected when NVR starts up).
13	AC 100V ~ 240V	AC 100V ~ 240V power supply.
14	POWER	Switch for turning on/off the device.

Peripheral Connections

Wiring of Alarm Input

The alarm input is an open/closed relay. To connect the alarm input to the device, use the following diagram.



If the alarm input is not an open/close relay, please connect an external relay between the alarm input and the device.

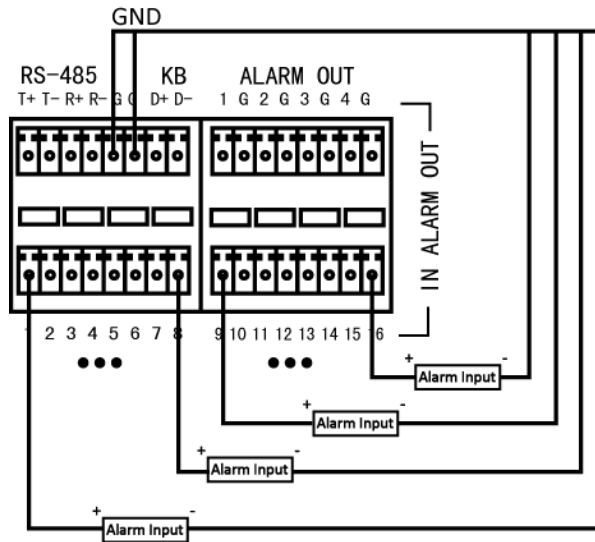

Wiring of Alarm Output

To connect to an alarm output (AC or DC load), use the following diagram:

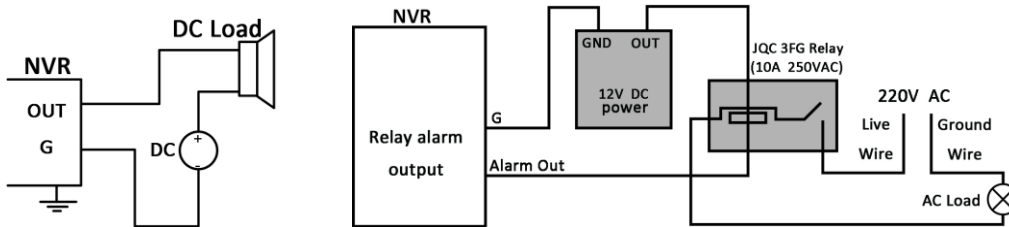

DC Load Connection Diagram

AC Load Connection Diagram

For DC load, the jumpers can be used within the limit of 12V/1A safely.

To connect an AC load, jumpers should be left open (you must remove the jumper on the motherboard in the NVR). Use an external relay for safety (as shown in the figure above).

There are 4 jumpers (JP1, JP2, JP3, and JP4) on the motherboard, each corresponding with one alarm output. By default, jumpers are connected. To connect an AC load, jumpers should be removed.

Example:

If you connect an AC load to the alarm output 3 of the NVR, then you must remove the JP 3.

Using of Alarm Connectors

To connect alarm devices to the NVR:

1. Disconnect *pluggable block* from the ALARM IN /ALARM OUT terminal block.
2. Unfasten stop screws from the *pluggable block*, insert signal cables into slots and fasten stop screws. Ensure signal cables are in tight.

3. Connect *pluggable block* back into terminal block.

Controller Connection

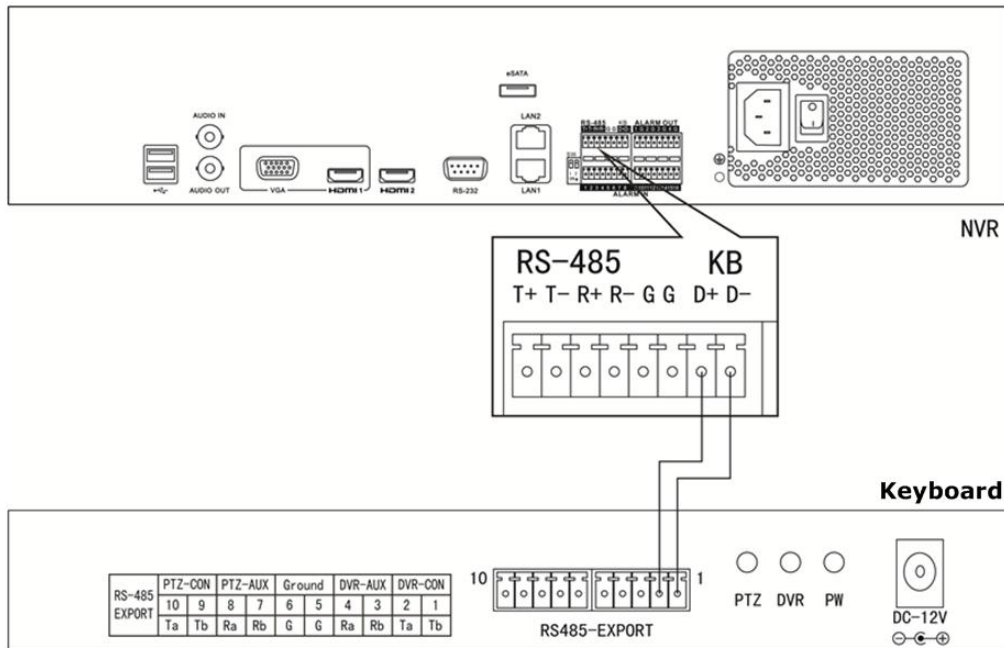

To connect a controller to the NVR:

1. Disconnect *pluggable block* from the KB terminal block.
2. Unfasten stop screws from the KB D+, D- *pluggable block*, insert signal cables into slots and fasten stop screws. Ensure signal cables are in tight.
3. Connect Ta on controller to D+ on terminal block and Tb on controller to D- on terminal block. Fasten stop screws.
4. Connect *pluggable block* back into terminal block.



Make sure both the controller and NVR are grounded.

Specifications

Model		LTN0732-R8	LTN0764-R8
Video/Audio input	IP video input	32-ch	64-ch
	Two-way audio	1-ch, RCA (2.0 Vp-p, 1kΩ)	
Network	Incoming bandwidth	384Mbps	768Mbps
	Outgoing bandwidth	768Mbps	
	Remote connection	128	
	Network Protocol	PRIVATE, ACTi, ARECONT, AXIS, BOSCH, BRICKCOM, CANON, HUNT, ONVIF (Version 2.4), PANASONIC, PELCO, PSIA, SAMSUNG, SANYO, SONY, VIVOTEK, ZAVIO	
	HDMI output	2-ch, resolution: HDMI1: 1920 × 1080P /60Hz, 1600 × 1200 /60Hz, 1280 × 1024 /60Hz, 1280 × 720 /60Hz, 1024 × 768 /60Hz; HDMI2: 3840×2160/30Hz, 1920 × 1080P /60Hz, 1600 × 1200 /60Hz, 1280 × 1024 /60Hz, 1280 × 720 /60Hz, 1024 × 768 /60Hz	
	VGA output	1-ch, resolution: 1920 × 1080P /60Hz, 1600 × 1200 /60Hz, 1280 × 1024 /60Hz, 1280 × 720 /60Hz, 1024 × 768 /60Hz	
	Audio output	1-ch, RCA (Linear, 1kΩ)	
Decoding	Decoding format	H.264, MPEG4, M-JPEG	
	Recording resolution	8MP/5MP/3MP/1080p/UXGA/720p/VGA/4CIF/DCIF/2CIF/CIF/QCIF	
	Synchronous playback	16-ch	
Hard disk	SATA	8 SATA interfaces for 4 HDDs + 1 DVD-R/W (default), or 8HDDs	
	eSATA	1 eSATA interface	
	Capacity	Up to 4TB capacity for each HDD	
Disk array	Array type	RAID0, RAID1, RAID5, RAID10	
	Number of array	8	
External interface	Network interface	2 RJ-45 10 /100 /1000 Mbps self-adaptive Ethernet interfaces	
	Serial interface	RS-232; RS-485; Keyboard;	
	USB interface	2 × USB 2.0 on front panel and 2 × USB 3.0 on rear panel	
	Alarm in/out	16/4	
Others	Power supply	100 ~ 240 VAC, 50 ~ 60 Hz	
	Consumption (without hard disk or DVD-R/W)	≤ 100 W	
	Working temperature	14°F ~ 131°F (-10 °C ~ +55 °C)	
	Working humidity	10 % ~ 90 %	
	Chassis	19-inch rack-mounted 2U chassis	
	Dimensions (W × D × H)	17.5" × 18.5" × 3.5" (445.0 × 470.0 × 90.0 mm)	
	Weight (without hard disk or DVD-R/W)	≤ 17.6 lb (8.0 Kg)	

HDD Storage Calculation Chart

The following chart shows an estimation of storage space used based on recording at one channel for an hour at a fixed bit rate.

Bit Rate	Storage Used
96K	42M
128K	56M
160K	70M
192K	84M
224K	98M
256K	112M
320K	140M
384K	168M
448K	196M
512K	225M
640K	281M
768K	337M
896K	393M
1024K	450M
1280K	562M
1536K	675M
1792K	787M
2048K	900M
4096K	1.8G
8192K	3.6G
16384K	7.2G



Please note that supplied values for storage space used is just for reference. The storage values in the chart are estimated by formulas and may have some deviation from actual value.

Accessing by Web Browser

Logging In

You can get access to the device via web browser. Open web browser, input the IP address of the device and then press Enter. The login interface appears.

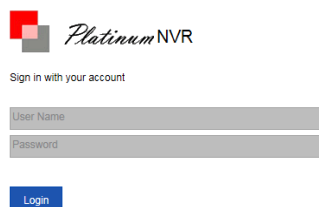

Input the user name and password, and click the **Login** button.



- The default IP address is 192.0.0.64.
- The default user name is admin, and password is 12345. You are highly recommended to change the initial password right after the first login to avoid safety problem.
- You may use one of the following listed web browsers: Internet Explorer 6.0, Internet Explorer 7.0, Internet Explorer 8.0, Internet Explorer 9.0, Internet Explorer 10.0, Apple Safari, Mozilla Firefox, and Google Chrome.
- The supported resolutions include 1024*768 and above.



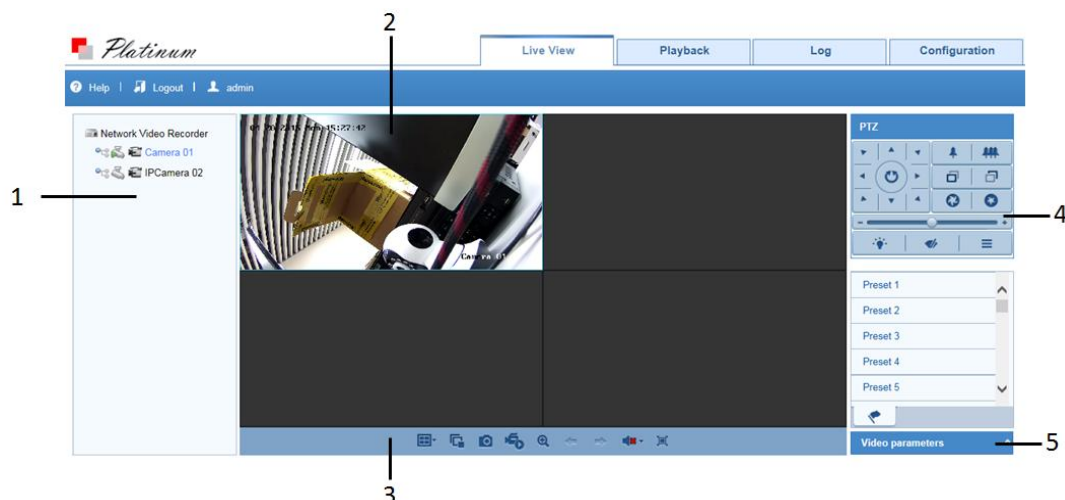

When you log in for the first time, the system will remind you to install the Plug-in control. After the installation, you can configure and manage the device remotely.

Live View

The live view interface appears by default when you log in the device.













Interface Introduction

No.	Name	Description
1	Channel List	Displays the list of channels and the playing and recording status of each channel.  NOTE The stream type can be switched by clicking the icon before the channel name:  stands for main stream and  for sub-stream.
2	Live View Window	Displays the image of channel, and multi-window division is supported.
3	Play Control Bar	Play control operations are supported.
4	PTZ Control	Pan, tilt, zoom operations are supported, as well as preset and patrol editing and calling.  NOTE PTZ function can only be realized if the connected camera supports PTZ control.
5	Video Parameters Configuration	Brightness, contrast, saturation and hue of the image can be edited.

Start Live View**Steps:**

1. In the live view window, select a playing window by clicking the mouse.
2. Double click a camera from the device list to start the live view.
3. You can click the  button on the toolbar to start the live view of all cameras on the device list.

Refer to the following table for the description of buttons on the live view window:

Icon	Description	Icon	Description
	Select the window-division mode		Open/Close audio
	Start/Stop all live view		Start/Stop two-way Audio
	Capture pictures in the live view mode		Adjust volume
	Start/Stop all recording		Enable/Disable digital zoom
	Previous/Next page		Full screen

Recording**Before you start**

Make sure the device is connected with HDD or network disk, and the HDD or network disk has been initialized for the first time to use.

Two recording types can be configured: Manual and Scheduled. The following section introduces the configuration of scheduled recording.

Steps:

1. Click Remote Configuration> Camera Settings> Record Schedule to enter Record Schedule settings interface.
2. Select the camera to configure the record schedule.

3. Check the checkbox of Enable Schedule to enable recording schedule.

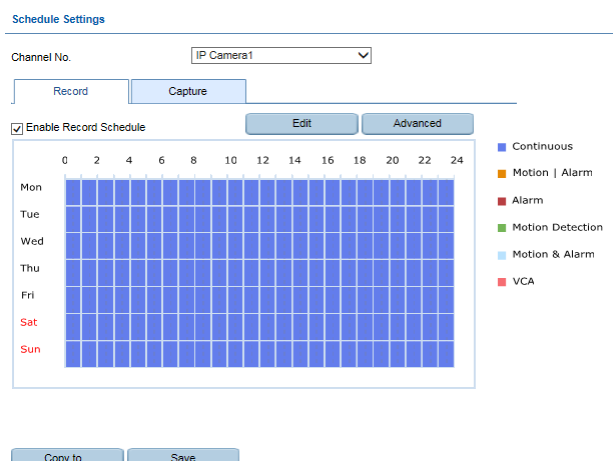

4. Choose the day in a week to configure scheduled recording.
5. Click **Edit** to edit record schedule.

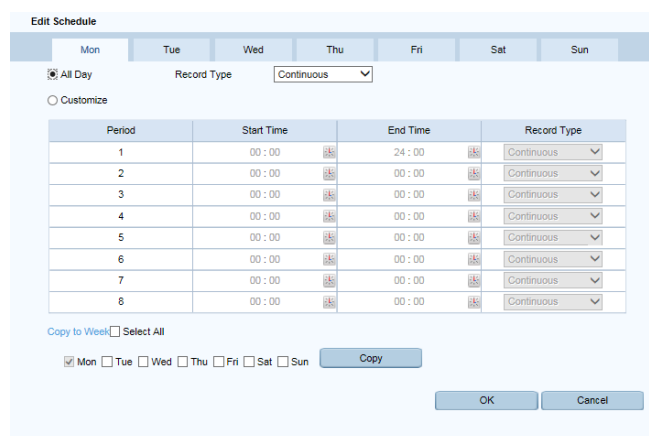

- 1) Configure All Day or Customize Record:
 - If you want to configure the all-day recording, please check the **All Day** checkbox.
 - If you want to record in different time sections, check the **Customize** checkbox. Set the **Start Time** and **End Time**.



Up to 8 segments can be configured and each segment cannot be overlapped.

- 2) Select a **Record Type**. The record type can be Continuous, Motion, Alarm, Motion & Alarm, Motion | Alarm and VCA.
 - 3) Check the checkbox of **Select All** and click **Copy** to copy settings of this day to the whole week. You can also check any of the checkboxes before the date and click **Copy**.
 - 4) Click **OK** to save the settings and exit the **Edit Schedule** interface.
6. Click **Advanced** to configure advanced record parameters.

You can configure parameters of enable ANR (Automatic Network Replenishment), Pre-record time, Post-record time, Stream Type, Record Audio and Expired Time.

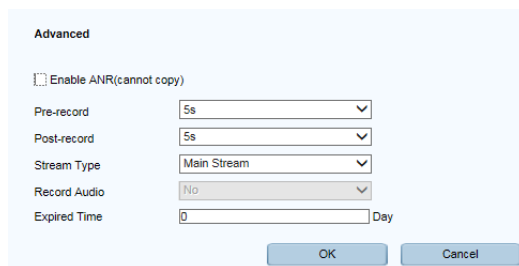

7. Click **Save** to validate the above settings.
8. (Optional) You can click the **Copy to...** button to copy the same setting to other cameras.

Playback

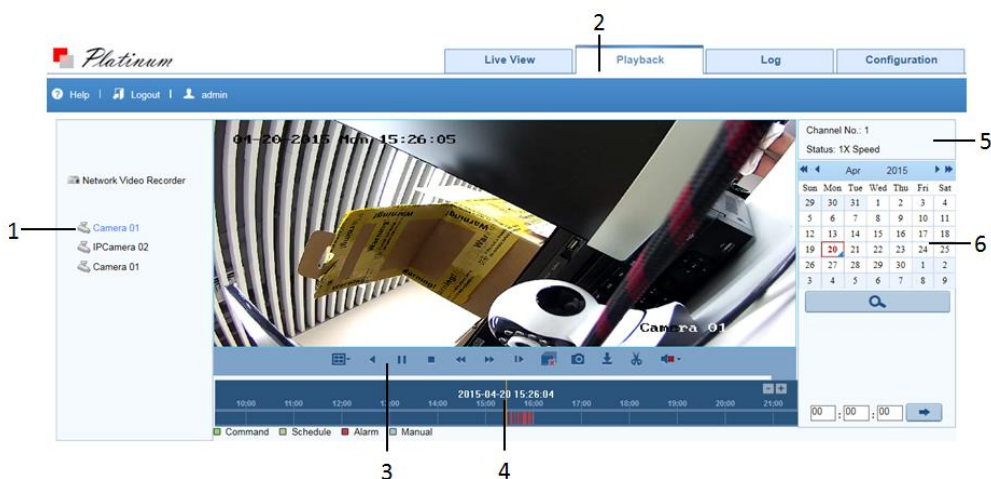

Interface Introduction

No.	Name	Description
1	Channel List	Displays the list of channels and the playing status of each channel.
2	Playback Window	Displays the image of channel.
3	Play Control Bar	Play control operations are supported.
4	Time Line	Displays the time bar and the records marked with different colors.
5	Playback Status	Displays the playback status, including channel number and playback speed.
6	Calendar	You can select the date to play.













Start Playback



Steps:

1. Click **Playback** on the menu bar to enter playback interface.
2. Click the camera from the device list for playback.
3. Select the date from the calendar and click **Search**.
4. Click the  button to play the searched video file on the current date.
5. Use the buttons on the toolbar to operate in playback mode.



Playback Control Buttons Description

Area	Description	Area	Description
	Play/Pause		Stop
	Slow down		Speed up
	Play by single frame		Capture
	Stop all playback		Download
	Video clip		Open/Close audio
	Reverse playback		Window division

6. You can drag the progress bar with the mouse to locate the exact playback point. You can also input the time in the textbox : :  and click  button to locate the playback point.

The color of the video on the progress bar stands for the different video types.

 Command  Schedule Recording  Alarm Recording  Manual Recording



To play back record files of multiple cameras at the same time, you may set the window division mode by clicking the  button and choose a window, and then repeat the above steps 2-4.

Log

You can view and export the log files at any time, including operation, alarm, exception and information of device.

Before you start:

The Log function can be realized only when the device is connected with HDD or network disk.

Steps:

1. Click **Log** on the menu bar to enter the Log interface.
2. Set the log search conditions to refine your search, including the Major Type, Minor Type, Start Time and End Time.
3. Click the **Search** button to start searching log files.
4. The matched log files will be displayed on the list.



Up to 2000 log files can be found each time, and 100 log files can be displayed on each page.

You can click the  Save Log button to save the searched log files to local directory.

Menu Operation

Menu Structure

The menu structure LTN07XX-R8 series NVR is shown below:

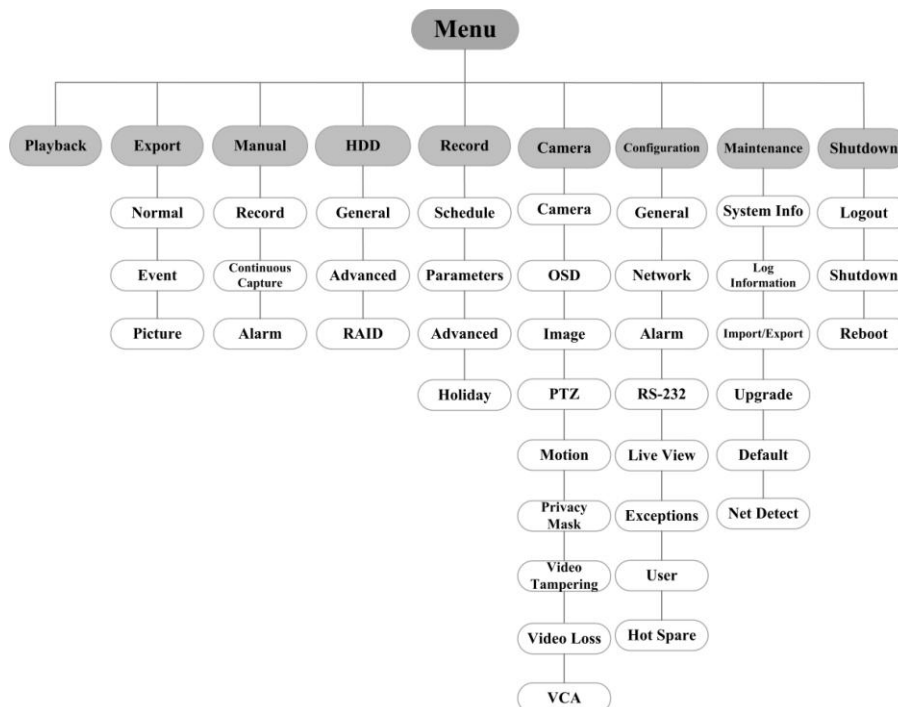

Startup and Shutdown

Proper startup and shutdown procedures are crucial to expanding the life of the NVR.

To start your NVR:

1. Check the power supply is plugged into an electrical outlet. It is HIGHLY recommended that an Uninterruptible Power Supply (UPS) be used in conjunction with the device. The Power button on the front panel should be red, indicating the device gets the power supply.
2. Press the POWER button on the front panel. The Power LED should turn blue. The unit will begin to start. After the device starting up, the wizard will guide you through the initial settings, including modifying password, date and time settings, network settings, HDD initializing, and recording.

To shut down the NVR:

1. Enter the Shutdown menu.

Menu > Shutdown

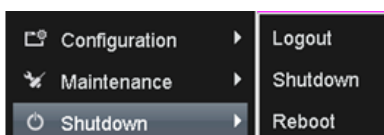

2. Select the **Shutdown** button.
3. Click the **Yes** button.

Live View

Some icons are provided on screen in Live View mode to indicate different camera status. These icons include:

Live View Icons

In the live view mode, there are icons at the upper-right corner of the screen for each channel, showing the status of the record and alarm in the channel, so that you can find problems as soon as possible.



Alarm (video loss, tampering, motion detection or sensor alarm)



Record (manual record, continuous record, motion detection or alarm triggered record)



Alarm & Record



Event/Exception (event and exception information, appears at the lower-left corner of the screen.)

Adding IP Cameras

You should add and configure the online IP cameras to enable the live view and recording function.

Steps:

1. Right-click the mouse when you in the live view mode to show the right-click menu.



2. Select **Add IP Camera** in the pop-up menu to enter the IP Camera Management interface.

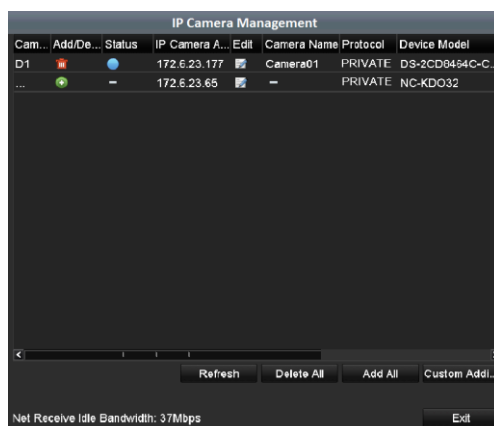

3. The online cameras with same network segment will be displayed in the camera list. Click the button to add the camera.

Or you can click the **One-couch Adding** button to add all the online IP cameras.



The added camera is marked in white while the camera has not been added is marked in yellow.

Explanation of the icons

Icon	Explanation	Icon	Explanation
	Edit basic parameters of the camera		Add the detected IP camera.
	The camera is connected.		The camera is disconnected; you can click the icon to get the exception information of camera.
	Delete the IP camera		Advanced settings of the camera.
	Update the IP camera		

4. To add other IP cameras:

- 1) Click the **Custom Adding** button to pop up the Add IP Camera (Custom) interface.

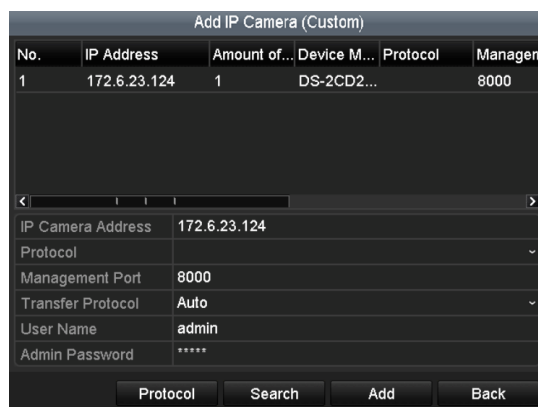

- 2) You can edit the IP address, protocol, management port, and other information of the IP camera to be added.
- 3) Click **Add** to add the camera.
- 4) (For the encoders with multiple channels only) check the checkbox of Channel Port in the pop-up window, as shown in the following figure, and click **OK** to finish adding.

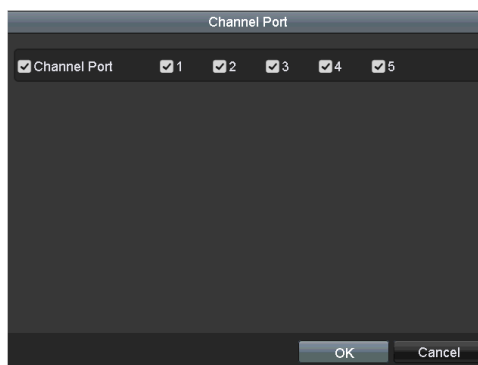

One-touch RAID Configuration

Purpose:

When the RAID is enabled, the disk array must be configured if you want to save recording and log files locally. Through one-touch configuration, you can quickly create the disk array. By default, the array type to be created is RAID 5.

Before you start:

As the default array type is RAID 5, at least 3 HDDs must be installed in you device.

Steps:

1. Enable the RAID function by checking the checkbox in the disk mode configuration interface.
Menu > HDD > Advanced
2. Enter the Physical Disk Settings interface.
Menu > HDD > RAID

No.	Capacity Array	Type	Status	Model	Hot Sp...
1	931.51GB	Normal	Functional	ST31000340NS	
3	931.51GB	Normal	Functional	ST31000526SV	
5	931.51GB	Normal	Functional	WDC WD10EVVS-6...	
7	931.51GB	Normal	Functional	WDC WD10EVVS-6...	

3. Click **One-touch Configuration** to enter the One-touch Array Configuration interface.

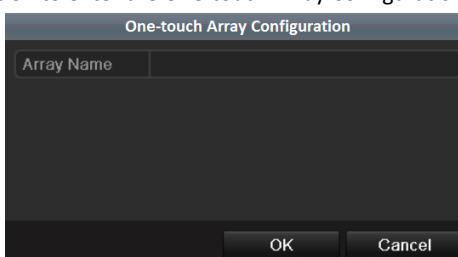

4. Edit the array name in the **Array Name** text field and click **OK** button to start configuring array.



If you install 4 HDDs or above for one-touch configuration, a hot spare disk will be set by default. It is recommended to set hot spare disk for automatically rebuilding the array when the array is abnormal.

5. When the array configuration is completed, click **OK** button in the pop-up message box to finish the settings.

Recording

Before you start:

Make sure that the HDD has already been installed. If not, please install a HDD and initialize it. You may refer to the user manual for detailed information.

Purpose:

Two kinds of record types are introduced in the following section, including Instant Record and All-day Record. And for other record types, you may refer to the user manual for detailed information.







After rebooting all the manual records enabled are canceled.

Instant Recording

On the live view window of each channel, there is a quick setting toolbar which shows on the bottom of the window when you click on it.



Click the  icon to enable the record, and the icon turns to . And click  icon to disable the record, then the icon turns to .

All-day Recording

Steps:

1. On the live view window, right click the window and move the cursor to the **Start Recording** option, and select **Continuous Record** or **Motion Detection Record** on your demand.
2. And click the **Yes** button in the popup Attention message box to confirm the settings. Then all the channels will start to record in the selected mode.

Playback

Play back the record files of a specific channel in the live view menu. Channel switch is supported.

● Option 1:

Choose a channel under live view using the mouse and click the  button in the shortcut operation menu.



Only record files recorded during the past five minutes on this channel will be played back.



● Option 2:

Steps:

1. Enter the Playback menu.
Mouse: right click a channel in live view mode and select Playback from the menu.
Front Panel: press PLAY button to play back record files of the channel under single-screen live view.
Under multi-screen live view, record files of the selected channel will be played back.



Pressing numerical buttons will switch playback to related channels during playback process.

2. Playback management.

The toolbar in the bottom part of Playback interface can be used to control playing process.



Just check the channel or channels if you want to switch playback to another channel or execute simultaneous playback of multiple channels.

Backup

Recorded files can be backed up to various devices, such as USB flash drives, USB HDDs or a DVD writer.

Steps:

1. Enter Video Export interface.

Choose the channel(s) you want to back up and click on the **Quick Export** button.

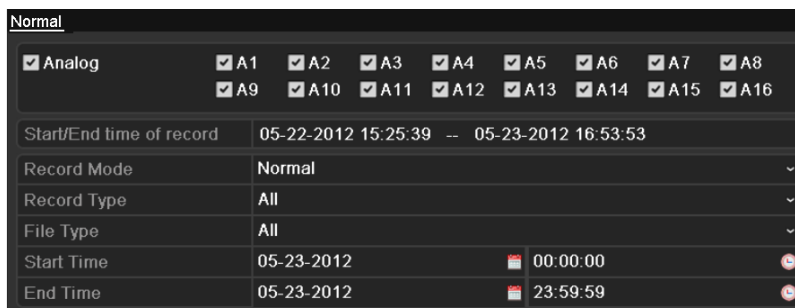

2. Enter Export interface, choose backup device and click **Export** button to start exporting.

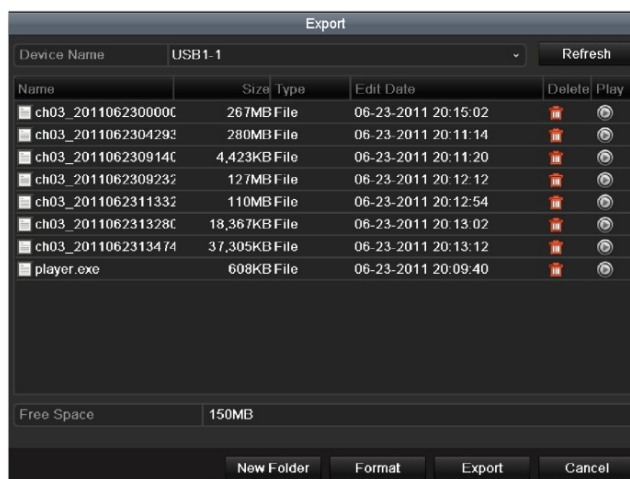

3. Check backup result.

Choose the record file in Export interface and click button  to check it.

