

Network Speed Dome

User Manual

User Manual

About this Manual

This Manual is applicable to Network Speed Dome.

The Manual includes instructions for using and managing the product. Pictures, charts, images and all other information hereinafter are for description and explanation only. The information contained in the Manual is subject to change, without notice, due to firmware updates or other reasons. Please find the latest version in the company website.

Please use this user manual under the guidance of professionals.

Legal Disclaimer

REGARDING TO THE PRODUCT WITH INTERNET ACCESS, THE USE OF PRODUCT SHALL BE WHOLLY AT YOUR OWN RISKS. OUR COMPANY SHALL NOT TAKE ANY RESPONSIBILITIES FOR ABNORMAL OPERATION, PRIVACY LEAKAGE OR OTHER DAMAGES RESULTING FROM CYBER ATTACK, HACKER ATTACK, VIRUS INSPECTION, OR OTHER INTERNET SECURITY RISKS; HOWEVER, OUR COMPANY WILL PROVIDE TIMELY TECHNICAL SUPPORT IF REQUIRED.

SURVEILLANCE LAWS VARY BY JURISDICTION. PLEASE CHECK ALL RELEVANT LAWS IN YOUR JURISDICTION BEFORE USING THIS PRODUCT IN ORDER TO ENSURE THAT YOUR USE CONFORMS THE APPLICABLE LAW. OUR COMPANY SHALL NOT BE LIABLE IN THE EVENT THAT THIS PRODUCT IS USED WITH ILLEGITIMATE PURPOSES.

IN THE EVENT OF ANY CONFLICTS BETWEEN THIS MANUAL AND THE APPLICABLE LAW, THE LATER PREVAILS.

Regulatory Information

FCC Information

FCC compliance: This equipment has been tested and found to comply with the limits for a digital device, pursuant to part 15 of the FCC Rules. These limits are designed to provide reasonable protection against harmful interference when the equipment is operated in a commercial environment. This equipment generates, uses, and can radiate radio frequency energy and, if not installed and used in accordance with the instruction manual, may cause harmful interference to radio communications. Operation of this equipment in a residential area is likely to cause harmful interference in which case the user will be required to correct the interference at his own expense.

FCC Conditions

This device complies with part 15 of the FCC Rules. Operation is subject to the following two conditions:

1. This device may not cause harmful interference.
2. This device must accept any interference received, including interference that may cause undesired operation.

EU Conformity Statement



This product and - if applicable - the supplied accessories too are marked with "CE" and comply therefore with the applicable harmonized European standards listed under the Low Voltage Directive 2006/95/EC, the EMC Directive 2004/108/EC, the RoHS Directive 2011/65/EU.



2012/19/EU (WEEE directive): Products marked with this symbol cannot be disposed of as unsorted municipal waste in the European Union. For proper recycling, return this product to your local supplier upon the purchase of equivalent new equipment, or dispose of it at designated collection points. For more information see: www.recyclethis.info.



2006/66/EC (battery directive): This product contains a battery that cannot be disposed of as unsorted municipal waste in the European Union. See the product documentation for specific battery information. The battery is marked with this symbol, which may include lettering to indicate cadmium (Cd), lead (Pb), or mercury (Hg). For proper recycling, return the battery to your supplier or to a designated collection point. For more information see: www.recyclethis.info.

Industry Canada ICES-003 Compliance

This device meets the CAN ICES-3 (A)/NMB-3(A) standards requirements.



Safety Instruction

These instructions are intended to ensure that the user can use the product correctly to avoid danger or property loss.

The precaution measure is divided into 'Warnings' and 'Cautions':

Warnings: Serious injury or death may be caused if any of these warnings are neglected.

Cautions: Injury or equipment damage may be caused if any of these cautions are neglected.

	
Warnings Follow these safeguards to prevent serious injury or death.	Cautions Follow these precautions to prevent potential injury or material damage.



Warnings:

- Please adopt the power adapter which can meet the safety extra low voltage (SELV) standard. The power consumption cannot be less than the required value.
- Do not connect several devices to one power adapter as an adapter overload may cause over-heating and can be a fire hazard.
- When the product is installed on a wall or ceiling, the device should be firmly fixed.
- To reduce the risk of fire or electrical shock, do not expose the indoor used product to rain or moisture.
- This installation should be made by a qualified service person and should conform to all the local codes.
- Please install blackouts equipment into the power supply circuit for convenient supply interruption.
- If the product does not work properly, please contact your dealer or the nearest service center. Never attempt to disassemble the product yourself. (We shall not assume any responsibility for problems caused by unauthorized repair or maintenance.)

**Cautions:**

- Make sure the power supply voltage is correct before using the product.
- Do not drop the product or subject it to physical shock. Do not install the product on vibratory surface or places.
- Do not expose it to high electromagnetic radiating environment.
- Do not aim the lens at the strong light such as sun or incandescent lamp. The strong light can cause fatal damage to the product.
- The sensor may be burned out by a laser beam, so when any laser equipment is being used, make sure that the surface of the sensor not be exposed to the laser beam.
- For working temperature, please refer to the specification manual for details.
- To avoid heat accumulation, good ventilation is required for a proper operating environment.
- While shipping, the product should be packed in its original packing.
- Please use the provided glove when open up the product cover. Do not touch the product cover with fingers directly, because the acidic sweat of the fingers may erode the surface coating of the product cover.
- Please use a soft and dry cloth when clean inside and outside surfaces of the product cover. Do not use alkaline detergents.
- Improper use or replacement of the battery may result in hazard of explosion. Please use the manufacturer recommended battery type.

Table of Contents

CHAPTER 1	OVERVIEW	1
1.1	SYSTEM REQUIREMENT	1
1.2	FUNCTIONS.....	1
CHAPTER 2	NETWORK CONNECTION	4
2.1	SETTING THE NETWORK SPEED DOME OVER THE LAN.....	4
2.1.1	<i>Wiring over the LAN</i>	4
2.1.2	<i>Activating the Speed Dome</i>	5
2.2	SETTING THE NETWORK SPEED DOME OVER THE WAN	9
2.2.1	<i>Static IP Connection</i>	9
2.2.2	<i>Dynamic IP Connection</i>	10
CHAPTER 3	ACCESS TO THE NETWORK SPEED DOME.....	13
3.1	ACCESSING BY WEB BROWSERS	13
3.2	ACCESSING BY CLIENT SOFTWARE.....	14
CHAPTER 4	BASIC OPERATIONS	16
4.1	POWER-UP ACTION	16
4.2	CONFIGURING LOCAL PARAMETERS	16
4.3	LIVE VIEW PAGE	18
4.4	STARTING LIVE VIEW	19
4.5	RECORDING AND CAPTURING PICTURES MANUALLY.....	20
4.6	OPERATING PTZ CONTROL	21
4.6.1	<i>PTZ Control Panel</i>	21
4.6.2	<i>Auxiliary Functions</i>	22
4.6.3	<i>Setting / Calling a Preset</i>	22
4.6.4	<i>Setting / Calling a Patrol</i>	24
4.6.5	<i>Setting / Calling a Pattern</i>	26
4.7	CONFIGURING LIVE VIEW PARAMETERS	27
CHAPTER 5	SYSTEM CONFIGURATIONS.....	28
5.1	STORAGE SETTINGS	28
5.1.1	<i>Configuring Recording Schedule</i>	28
5.1.2	<i>Configuring Net HDD</i>	31
5.1.3	<i>Configuring Snapshot Settings</i>	32
5.2	BASIC EVENT CONFIGURATION.....	33
5.2.4	<i>Configuring Motion Detection</i>	33
5.2.5	<i>Configuring Video Loss Alarm</i>	37
5.2.6	<i>Configuring Video Tampering Alarm</i>	38
5.2.7	<i>Configuring Alarm Input</i>	39
5.2.8	<i>Configuring Alarm Output</i>	40
5.2.9	<i>Handling Exception</i>	41
5.3	SMART EVENT CONFIGURATION	41

5.3.1	<i>Detecting Audio Exception</i>	41
5.3.2	<i>Configuring Intrusion Detection</i>	42
5.3.3	<i>Configuring Line Crossing Detection</i>	44
5.3.4	<i>Region Entrance Detection</i>	45
5.3.5	<i>Region Exiting Detection</i>	46
5.4	PTZ CONFIGURATION	47
5.4.1	<i>Configuring Initial Position</i>	47
5.4.2	<i>Configuring Basic PTZ Parameters</i>	48
5.4.3	<i>Configuring PTZ Limits</i>	50
5.4.4	<i>Configuring Scheduled Tasks</i>	51
5.4.5	<i>Configuring Park Actions</i>	52
5.4.6	<i>Configuring Privacy Mask</i>	53
5.4.7	<i>Clearing PTZ Configurations</i>	54
5.4.8	<i>Configuring Smart Tracking</i>	54
5.4.9	<i>Configuring PTZ Control Priority</i>	55
CHAPTER 6	SPEED DOME CONFIGURATION	56
6.1	CONFIGURING LOCAL PARAMETERS	56
6.2	CONFIGURING TIME SETTINGS	57
6.3	CONFIGURING NETWORK SETTINGS	59
6.3.1	<i>Configuring TCP/IP Settings</i>	59
6.3.2	<i>Configuring Port Settings</i>	60
6.3.3	<i>Configuring PPPoE Settings</i>	61
6.3.4	<i>Configuring DDNS Settings</i>	61
6.3.5	<i>Configuring SNMP Settings</i>	64
6.3.6	<i>Configuring 802.1X Settings</i>	65
6.3.7	<i>Configuring QoS Settings</i>	67
6.3.8	<i>Configuring FTP Settings</i>	67
6.3.9	<i>Configuring UPnP™ Settings</i>	69
6.3.10	<i>Configuring NAT (Network Address Translation) Settings</i>	69
6.3.11	<i>Configuring Email Settings</i>	70
6.3.12	<i>Configuring Platform Access Settings</i>	71
6.3.13	<i>Configuring HTTPS Settings</i>	71
6.4	CONFIGURING VIDEO AND AUDIO SETTINGS	73
6.4.1	<i>Configuring Video Settings</i>	73
6.4.2	<i>Configuring Audio Settings</i>	74
6.4.3	<i>Configuring ROI Settings</i>	75
6.4.4	<i>Configuring Dual-VCA</i>	76
6.5	CONFIGURING IMAGE SETTINGS	76
6.5.1	<i>Configuring Display Settings</i>	76
6.5.2	<i>Configuring OSD Settings</i>	82
6.5.3	<i>Configuring Text Overlay Settings</i>	83
CHAPTER 7	PLAYBACK	85
CHAPTER 8	LOG SEARCHING	88

CHAPTER 9	OTHERS	89
9.1	MANAGING USER ACCOUNTS.....	89
9.2	CONFIGURING AUTHENTICATION SECURITY	90
9.3	CONFIGURING ANONYMOUS VISIT	91
9.4	CONFIGURING IP ADDRESS FILTER.....	91
9.5	SECURITY SERVICE.....	92
9.6	VIEWING DEVICE INFORMATION	92
9.7	MAINTENANCE.....	93
9.7.1	<i>Rebooting the Speed Dome</i>	93
9.7.2	<i>Restoring Default Settings</i>	93
9.7.3	<i>Importing/Exporting Configuration File</i>	94
9.7.4	<i>Upgrading the System</i>	94
9.8	CONFIGURING RS-485	95
9.9	CONFIGURING IR LIGHT	95
9.10	CONFIGURING REMOTE CONNECTION	96
APPENDIX	97
	APPENDIX 1 IP PORTAL SOFTWARE INTRODUCTION.....	97
	APPENDIX 2 PORT MAPPING	99
	APPENDIX 3 STATICS, INTERFERENCE LIGHTNING AND SURGE PROTECTION	101
	APPENDIX 4 WATERPROOF	105
	APPENDIX 5 BUBBLE MAINTENANCE	106
	APPENDIX 6 RS485 BUS CONNECTION.....	107
	APPENDIX 7 24VAC WIRE GAUGE & TRANSMISSION DISTANCE	109
	APPENDIX 8 12VDC WIRE GAUGE & TRANSMISSION DISTANCE.....	110
	APPENDIX 9 TABLE OF WIRE GAUGE STANDARDS.....	111
	APPENDIX 10 ALARM IN/OUT CONNECTIONS.....	112

Chapter 1 Overview

1.1 System Requirement

System requirement of web browser accessing is as follows:

Operating System: Microsoft Windows XP SP1 and above version / Vista / Win7 / Server 2003 / Server 2008 32bits

CPU: Intel Pentium IV 3.0 GHz or higher

RAM: 1G or higher

Display: 1024×768 resolution or higher

Web Browser: Internet Explorer 8.0 and above version, Apple Safari 5.02 and above version, Mozilla Firefox 5 and above version and Google Chrome 18 and above versions.

1.2 Functions



The functions vary depending on the models of speed dome.

- **PTZ Limits**

The dome can be programmed to move within the PTZ limits (left/right, up/down).

- **Scan Modes**

The dome provides 5 scan modes: auto scan, tilt scan, frame scan, random scan and panorama scan.

- **Preset Freezing**

This feature freezes the scene on the monitor when the dome is moving to a preset. This allows for smooth transition from one preset scene to another. It also guarantees that masked area will not be revealed when the dome is moving to a preset.

- **Presets**

A preset is a predefined image position. When the preset is called, the dome will automatically move to the defined position. The presets can be added, modified, deleted and called.

- **Label Display**

The on-screen label of the preset title, azimuth/elevation, zoom, time and dome name can be displayed on the monitor. The displays of time and speed dome name can be programmed.

- **Auto Flips**

In manual tracking mode, when a target object goes directly beneath the dome, the video will automatically flips 180 degrees in horizontal direction to maintain continuity of tracking. This function can also be realized by auto mirror image depending on different camera models.

- **Privacy Mask**

This function allows you to block or mask certain area of a scene, for preventing the personal privacy from recording or live viewing. A masked area will move with pan and tilt functions and automatically adjust in size as the lens zooms telephoto and wide.

- **3D Positioning**

In the client software, use the left key of mouse to click on the desired position in the video image and drag a rectangle area in the lower right direction, then the dome system will move the position to the center and allow the rectangle area to zoom in. Use the left key of mouse to drag a rectangle area in the upper left direction to move the position to the center and allow the rectangle area to zoom out.

- **Proportional Pan/Tilt**

Proportional pan/tilt automatically reduces or increases the pan and tilt speeds according to the amount of zoom. At telephoto zoom settings, the pan and tilt speeds will be slower than at wide zoom settings. This keeps the image from moving too fast on the live view image when there is a large amount of zoom.

- **Auto Focus**

The auto focus enables the camera to focus automatically to maintain clear video images.

- **Day/Night Auto Switch**

The speed domes deliver color images during the day. And as light diminishes at night, the speed domes switch to night mode and deliver black and white images with high quality.

- **Slow Shutter**

In slow shutter mode, the shutter speed will automatically slow down in low illumination conditions to maintain clear video images by extending the exposure time. The feature can be enabled or disabled.

- **Backlight Compensation (BLC)**

If you focus on an object against strong backlight, the object will be too dark to be seen clearly. The BLC (Backlight Compensation) function can compensate light to the object in the front to make it clear, but this causes the over-exposure of the background where the light is strong.

- **Wide Dynamic Range (WDR)**

The wide dynamic range (WDR) function helps the camera provide clear images even under back light circumstances. When there are both very bright and very dark areas simultaneously in the field of view, WDR balances the brightness level of the whole image and provide clear images with details.



This feature varies depending on speed dome models.

- **White Balance (WB)**

White balance can remove the unrealistic color casts. White balance is the white rendition function of the camera to adjust the color temperature according to the environment automatically.

- **Patrol**

A patrol is a memorized series of pre-defined preset function. The scanning speed between two presets and the dwell time at the preset are programmable.

- **Pattern**

A pattern is a memorized series of pan, tilt, zoom, and preset functions. By default the focus and iris are in auto status during the pattern is being memorized.

- **Power Off Memory**

The dome supports the power off memory capability with the predefined resume time. It allows the dome to resume its previous position after power is restored.

- **Time Task**

A time task is a preconfigured action that can be performed automatically at a specific date and time. The programmable actions include: auto scan, random scan, patrol 1-8 ,pattern 1-4, preset 1-8,frame scan, panorama scan, tilt scan, day, night, reboot, PT adjust, Aux Output, etc.

- **Park Action**

This feature allows the dome to start a predefined action automatically after a period of inactivity.

- **User Management**

The dome allows you to edit users with different levels of permission, in the admin login status. Multiple users are allowed to access and control the same network speed dome via network simultaneously.

- **3D Digital Noise Reduction**

Comparing with the general 2D digital noise reduction, the 3D digital noise reduction function processes the noise between two frames besides processing the noise in one frame. The noise will be much less and the video will be clearer.

- **Dual-VCA**

Combine the detected VCA information into the video stream, which can be used for the second-time analysis on the back-end device.

Chapter 2 Network Connection

Before you start:

- If you want to set the network speed dome via a LAN (Local Area Network), please refer to **Section 2.1**.
- If you want to set the network speed dome via a WAN (Wide Area Network), please refer to **Section 2.2**.

2.1 Setting the Network Speed Dome over the LAN

Purpose:

To view and configure the speed dome via a LAN, you need to connect the network speed dome in the same subnet with your computer, and install the IP PORTAL or client software to search and change the IP of the network speed dome.



For the detailed introduction of IP PORTAL, please refer to Appendix 1.

2.1.1 Wiring over the LAN

The following figures show the two ways of cable connection of a network speed dome and a computer:

Purpose:

- To test the network speed dome, you can directly connect the network speed dome to the computer with a network cable as shown in Figure 2-1.
- Refer to the Figure 2-2 to set the network speed dome over the LAN via a switch or a router.

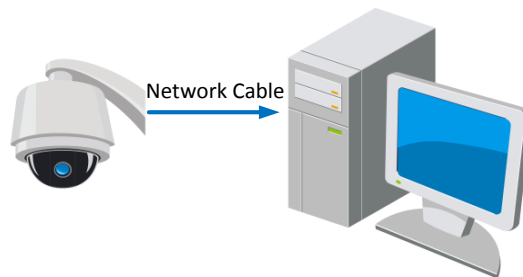

Figure 2-1 Connecting Directly

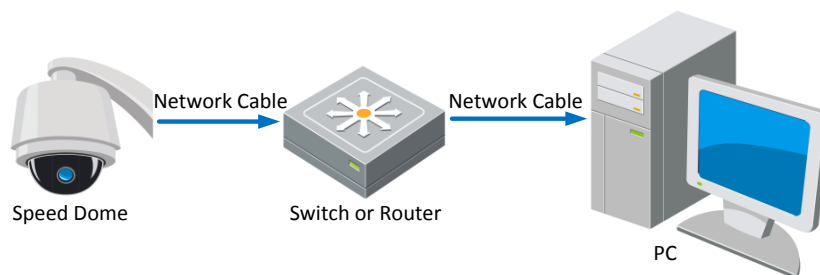

Figure 2-2 Connecting via a Switch or a Router

2.1.2 Activating the Speed Dome

Purpose:

You are required to activate the speed dome first before you can use the speed dome.

Activation via Web Browser, Activation via IP PORTAL, and Activation via client software are supported. In the following sections, activation via web browser and IP PORTAL will be taken as examples. You may refer to the user manual of the speed dome for the details of activation via client software.

◆ **Activation via Web Browser**

Steps:

1. Power on the speed dome, and connect the speed dome to the network.
2. Input the IP address into the address bar of the web browser, and click Enter to enter the activation interface.



The default IP address of the speed dome is 192.0.0.64.



Your password is weak. Please use a strong password to ensure your information security. Continue?

Figure 2-3 Activation Interface(Web)

3. Create a password and input the password into the password field.



STRONG PASSWORD RECOMMENDED—We highly recommend you create a strong password of your own choosing (Using a minimum of 8 characters, including at least three of the following categories: upper case letters, lower case letters, numbers, and special characters.) in order to increase the security of your product. And we recommend you reset your password regularly, especially in the high security system, resetting the password monthly or weekly can better protect your product.

4. Confirm the password.
5. Click **OK** to activate the speed dome and enter the live view interface.

◆ **Activation via IP PORTAL Software**

IP PORTAL software is used for detecting the online device, activating the device, and resetting the password.

Get the IP PORTAL software from the supplied disk or the official website, and install the IP PORTAL according to the prompts. Follow the steps to activate the speed dome.

Steps:

1. Run the IP PORTAL software to search the online devices.
2. Check the device status from the device list, and select an inactive device.

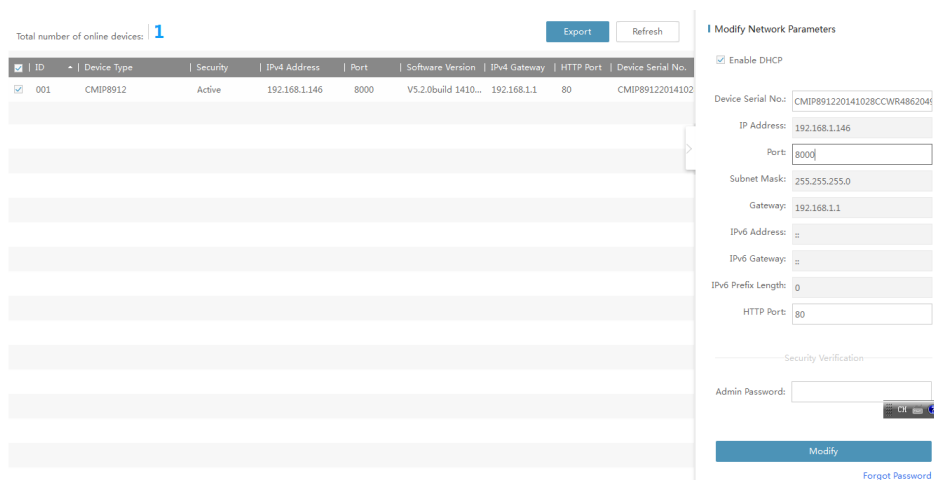

Figure 2-4 IP PORTAL Interface

3. Create a password and input the password in the password field, and confirm the password.



STRONG PASSWORD RECOMMENDED—We highly recommend you create a strong password of your own choosing (Using a minimum of 8 characters, including at least three of the following categories: upper case letters, lower case letters, numbers, and special characters.) in order to increase the security of your product. And we recommend you reset your password regularly, especially in the high security system, resetting the password monthly or weekly can better protect your product.

4. Click **OK** to save the password.

You can check whether the activation is completed on the popup window. If activation failed, please make sure that the password meets the requirement and then try again.

5. Change the device IP address to the same subnet with your computer by either modifying the IP address manually or checking the checkbox of Enable DHCP.

Modify Network Parameters

Enable DHCP

Device Serial No.: LTN8616-P161620160614CCRR611

IP Address: 192.0.0.64

Port: 8000

Subnet Mask: 255.255.255.0

Gateway: 192.0.0.1

IPv6 Address: fe80::bead:28ff:fe9e:8a38

IPv6 Gateway: ::

IPv6 Prefix Length: 64

HTTP Port: 80

Security Verification

Admin Password:

[Forgot Password](#)

[Modify](#)

Figure 2-5 Modify the IP Address

6. Input the password and click the **Save** button to activate your IP address modification.

◆ Activation via Client Software

The client software is versatile video management software for multiple kinds of devices. Get the client software from the supplied disk or the official website, and install the software according to the prompts. Follow the steps to activate the camera.

Steps:

1. Run the client software and the control panel of the software pops up, as shown in the figure below.

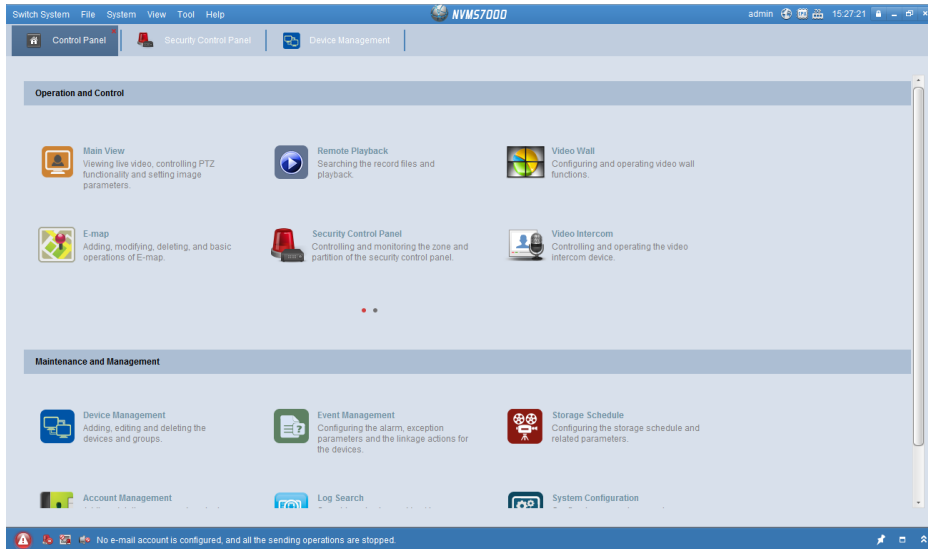

Figure 2-6 Control Panel

2. Click the **Device Management** icon to enter the Device Management interface, as shown in the figure below.

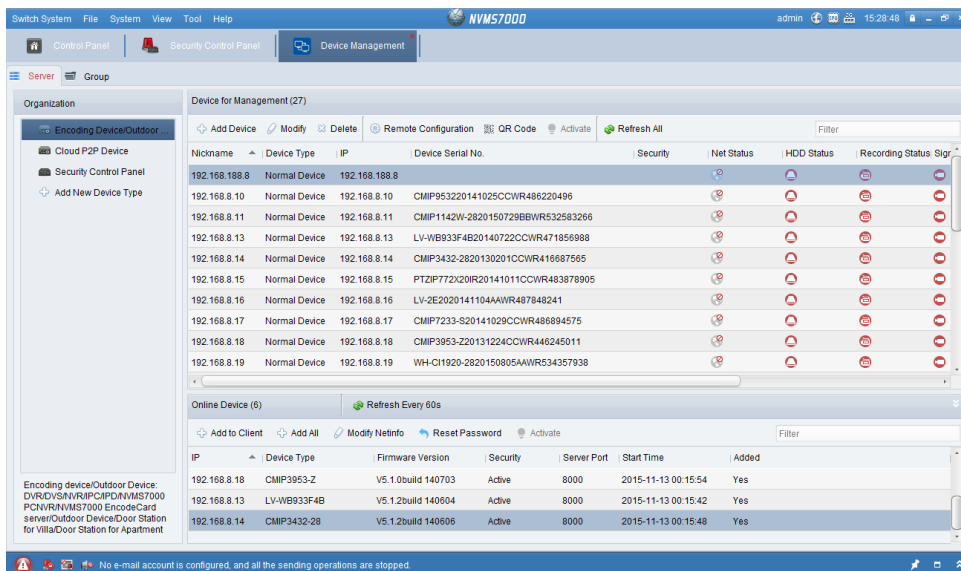

Figure 2-7 Device Management Interface

3. Check the device status from the device list, and select an inactive device.
4. Click the **Activate** button to pop up the Activation interface.
5. Create a password and input the password in the password field, and confirm the password.



STRONG PASSWORD RECOMMENDED—We highly recommend you create a strong password of your own choosing (Using a minimum of 8 characters, including at least three of the following categories: upper case letters, lower case letters, numbers, and special characters.) in order to increase the security of your product. And we recommend you reset your password regularly, especially in the high security system, resetting the password monthly or weekly can better protect your product.



The 'Activation' dialog box contains the following fields and text:

- User Name:** admin
- Password:** [masked with dots] with a strength indicator showing 'Strong'.
- Confirm Password:** [masked with dots]
- Text:** Valid password range [8-16]. You can use a combination of numbers, lowercase, uppercase and special character for your password with at least two kinds of them contained.
- Buttons:** OK and Cancel.

Figure 2-8 Activation Interface

6. Click **OK** button to start activation.
7. Click the **Modify Netinfo** button to pop up the Network Parameter Modification interface, as shown in the figure below.

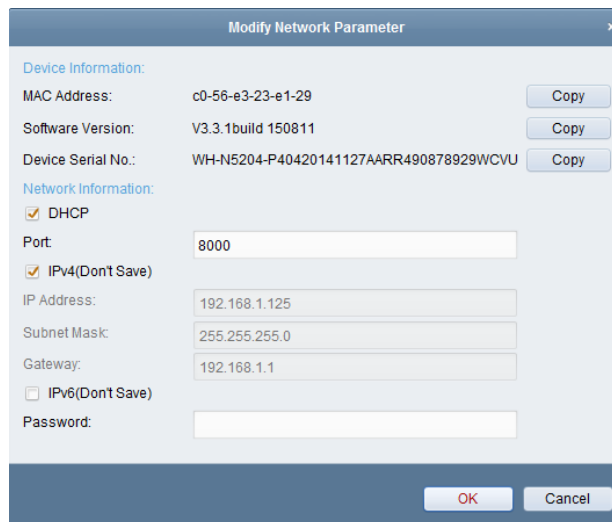

The 'Modify Network Parameter' dialog box contains the following sections and fields:

- Device Information:**
 - MAC Address: c0-56-e3-23-e1-29 [Copy]
 - Software Version: V3.3.1build 150811 [Copy]
 - Device Serial No.: WH-N5204-P40420141127AARR490878929WCVU [Copy]
- Network Information:**
 - DHCP
 - Port: 8000
 - IPv4(Don't Save)
 - IP Address: 192.168.1.125
 - Subnet Mask: 255.255.255.0
 - Gateway: 192.168.1.1
 - IPv6(Don't Save)
 - Password: [empty field]
- Buttons:** OK and Cancel.

Figure 2-9 Modifying the Network Parameters

8. Change the device IP address to the same subnet with your computer by either modifying the IP address manually or checking the checkbox of Enable DHCP.
9. Input the password to activate your IP address modification.

2.2 Setting the Network Speed Dome over the WAN

Purpose:

This section explains how to connect the network speed dome to the WAN with a static IP or a dynamic IP.

2.2.1 Static IP Connection

Before you start:

Please apply a static IP from an ISP (Internet Service Provider). With the static IP address, you can connect the network speed dome via a router or connect it to the WAN directly.

- **Connecting the network speed dome via a router**

Steps:

1. Connect the network speed dome to the router.
2. Assign a LAN IP address, the subnet mask and the gateway. Refer to **Section 2.1.2** for detailed IP address configuration of the speed dome.
3. Save the static IP in the router.
4. Set port mapping, E.g., 80, 8000 and 554 ports. The steps for port mapping vary depending on different routers. Please call the router manufacturer for assistance with port mapping.



Refer to Appendix 2 for detailed information about port mapping.

5. Visit the network speed dome through a web browser or the client software over the internet.

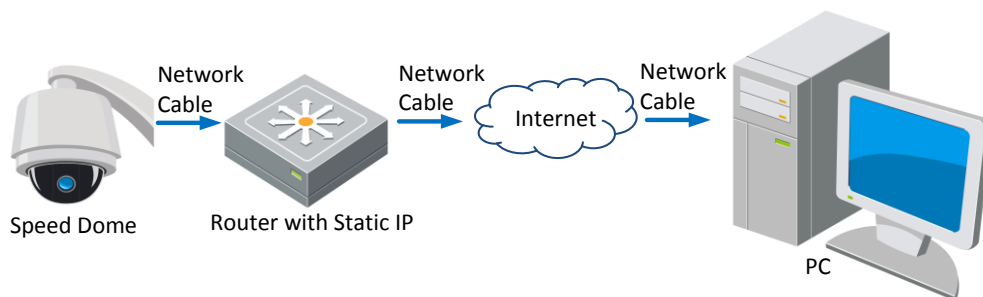

Figure 2-10 Accessing the Speed Dome through Router with Static IP



- **Connecting the network speed dome with static IP directly**

You can also save the static IP in the speed dome and directly connect it to the internet without using a router. Refer to **Section 2.1.2** for detailed IP address configuration of the speed dome.

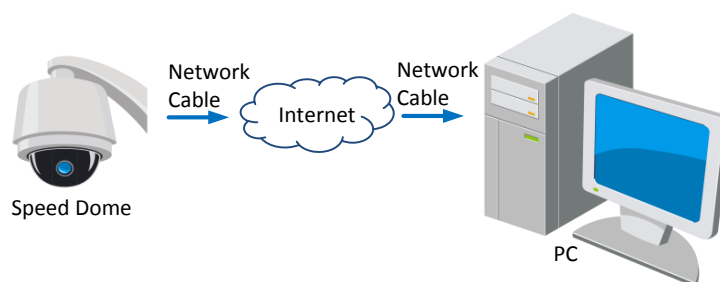

Figure 2-11 Accessing the Speed Dome with Static IP Directly

2.2.2 Dynamic IP Connection

Before you start:

Please apply a dynamic IP from an ISP. With the dynamic IP address, you can connect the network speed dome to a modem or a router.

- **Connecting the network speed dome via a router**

Steps:

1. Connect the network speed dome to the router.
2. In the speed dome, assign a LAN IP address, the subnet mask and the gateway. Refer to **Section 2.1.2** for detailed LAN configuration.
3. In the router, set the PPPoE user name, password and confirm the password.



- *For your privacy and to better protect your system against security risks, we strongly recommend the use of strong passwords for all functions and network devices. The password should be something of your own choosing (using a minimum of 8 characters, including upper case letters, lower case letters, numbers and special characters) in order to increase the security of your product.*
 - *Proper configuration of all passwords and other security settings is the responsibility of the installer and/or end-user.*
4. Set port mapping. E.g. 80, 8000 and 554 ports. The steps for port mapping vary depending on different routers. Please call the router manufacturer for assistance with port mapping.



Refer to Appendix 2 for detailed information about port mapping.

5. Apply a domain name from a domain name provider.
6. Configure the DDNS settings in the setting interface of the router.
7. Visit the speed dome via the applied domain name.



- **Connecting the network speed dome via a modem**

Purpose:

This speed dome supports the PPPoE auto dial-up function. The speed dome gets a public IP address by ADSL dial-up after the speed dome is connected to a modem. You need to configure the PPPoE parameters of the network speed dome. Refer to **Section 6.3.3 Configuring PPPoE Settings** for detailed configuration.

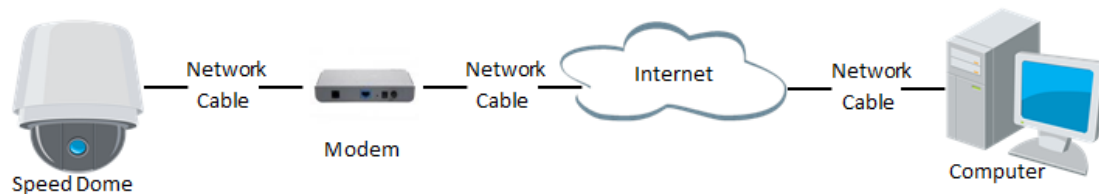

Figure 2-12 Accessing the Speed Dome with Dynamic IP



The obtained IP address is dynamically assigned via PPPoE, so the IP address always changes after rebooting the speed dome. To solve the inconvenience of the dynamic IP, you need to

get a domain name from the DDNS provider (E.g. DynDns.com). Please follow below steps for normal domain name resolution and private domain name resolution to solve the problem.

◆ Normal Domain Name Resolution

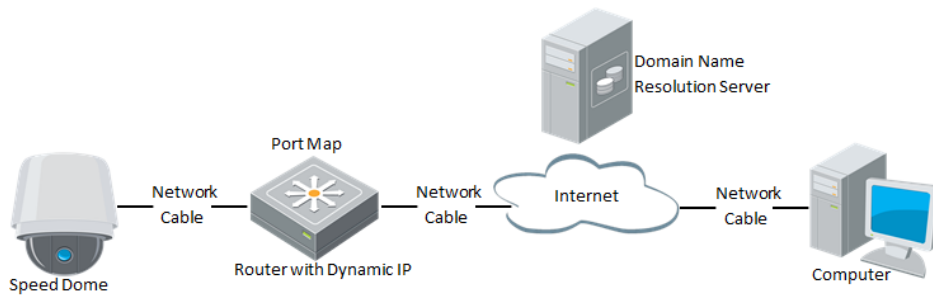

Figure 2-13 Normal Domain Name Resolution

Steps:

1. Apply a domain name from a domain name provider.
2. Configure the DDNS settings in the **DDNS Settings** interface of the network speed dome. Refer to **Section 6.3.4 Configuring DDNS Settings** for detailed configuration.
3. Visit the speed dome via the applied domain name.



◆ Private Domain Name Resolution

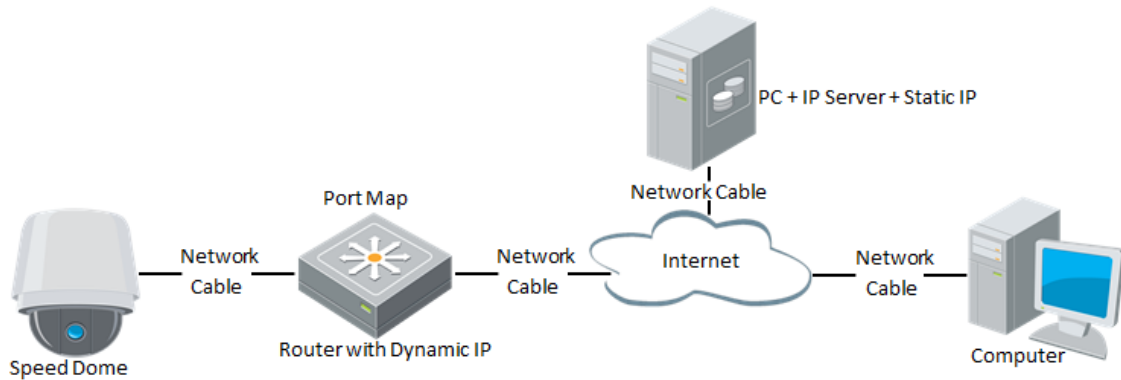

Figure 2-14 Private Domain Name Resolution

Steps:

1. Install and run the IP Server software in a computer with a static IP.
2. Access the network speed dome through the LAN with a web browser or the client software.
3. Enable DDNS and select IP Server as the protocol type. Refer to **Section 6.3.4 Configuring DDNS Settings** for detailed configuration.



Chapter 3 Access to the Network

Speed Dome

3.1 Accessing by Web Browsers

Steps:

1. Open the web browser.
2. In the address field, input the IP address of the network speed dome, e.g., 192.0.0.64 and press the **Enter** key to enter the login interface.
3. Activate the speed dome for the first time using, refer to the section **2.1.2 Activating the Speed Dome**.
4. Select English as the interface language on the top-right of login interface.
5. Input the user name and password and click .

The admin user should configure the device accounts and user/operator permissions properly. Delete the unnecessary accounts and user/operator permissions.



The device IP address gets locked if the admin user performs 7 failed password attempts (5 attempts for the user/operator).

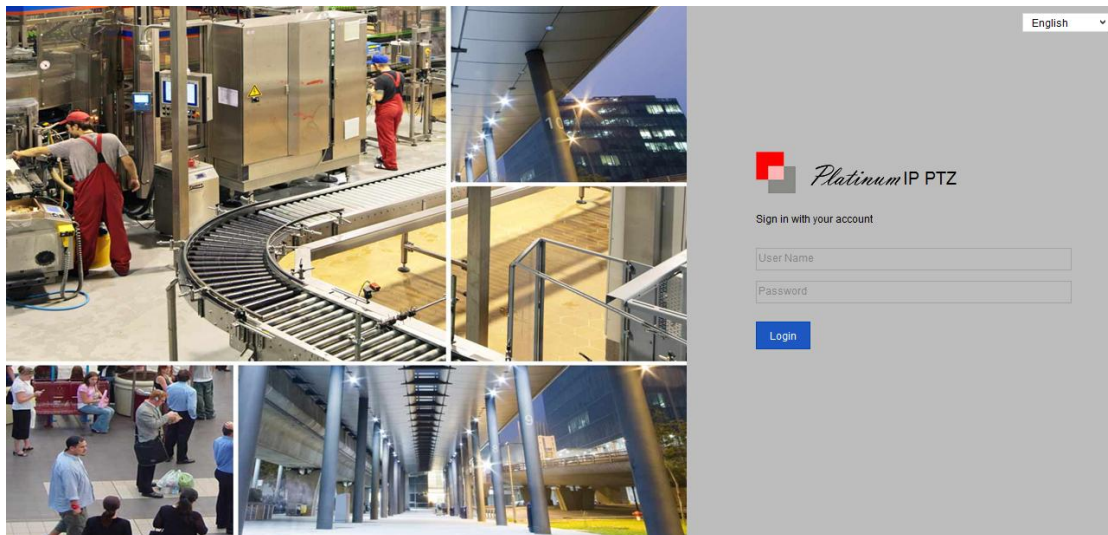

Figure 3-1 Login Interface

6. Install the plug-in before viewing the live video and operating the speed dome. Please follow the installation prompts to install the plug-in.

[Please click here to download and install the plug-in. Close the browser when installing the plug-in.](#)

Figure 3-2 Download and Install Plug-in

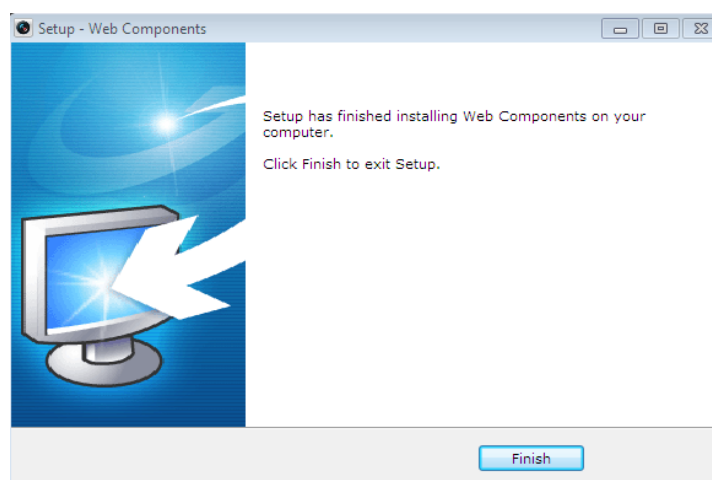

Figure 3-3 Install Plug-in



You may have to close the web browser to install the plug-in. Please reopen the web browser and log in again after installing the plug-in.

3.2 Accessing by Client Software

The product CD contains the client software. You can view the live video and manage the speed dome with the client software.

Follow the installation prompts to install the client software and WinPcap. The configuration interface and live view interface of client software are shown below.

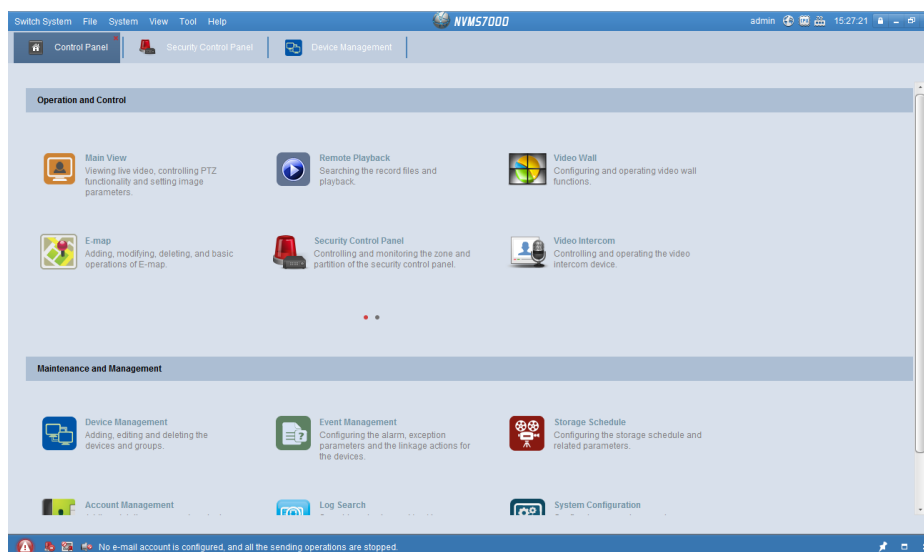

Figure 3-4 NVMS7000 Control Panel

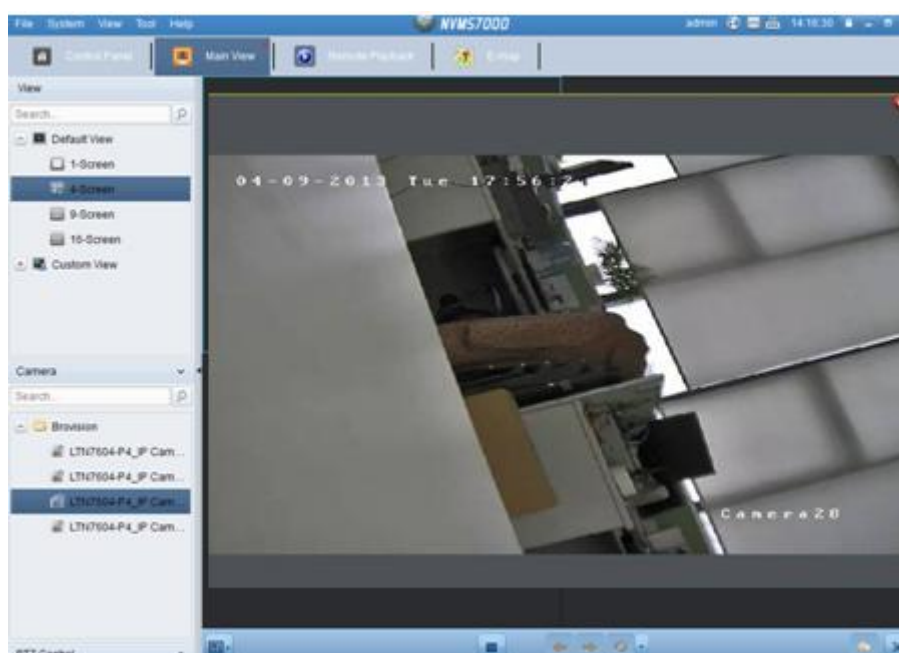

Figure 3-5 NVMS7000 Live View Interface



- If you use third party VMS software, please contact technical support of our branch for camera firmware.
- For detailed information about client software of our company, please refer to the user manual of the software. This manual mainly introduces accessing to the network speed dome by web browser.

Chapter 4 Basic Operations

In this and the following chapters, operation of the speed dome by the web browser will be taken as an example.

4.1 Power-up Action

After the power is applied, the speed dome will perform self-test actions. It begins with lens actions and then pan and tilt movement. After the power-up self-test actions, the information as shown in Figure 4-1 will be displayed on screen for 40 seconds.

The System Information displayed on the screen includes the dome model, address, protocol, version and other information. The COMMUNICATION refers to the baud rate, parity, data bit and stop bit of the dome. e.g., "2400, N, 8, 1" indicates the dome is configured with the baud rate of 2400, no parity, 8 data bits and 1 stop bit.

Model	XX-XXXXXX-X
Address	0
Communication	0000,0,0,0
Software Version	Vx.x.x
Camera Version	Vx.xx
Language	English

Figure 4-1 Power-up Information

4.2 Configuring Local Parameters



The local configuration refers to the parameters of the live view and other operations using the web browser.

Steps:

1. Enter the Local Configuration interface:
Configuration > Local

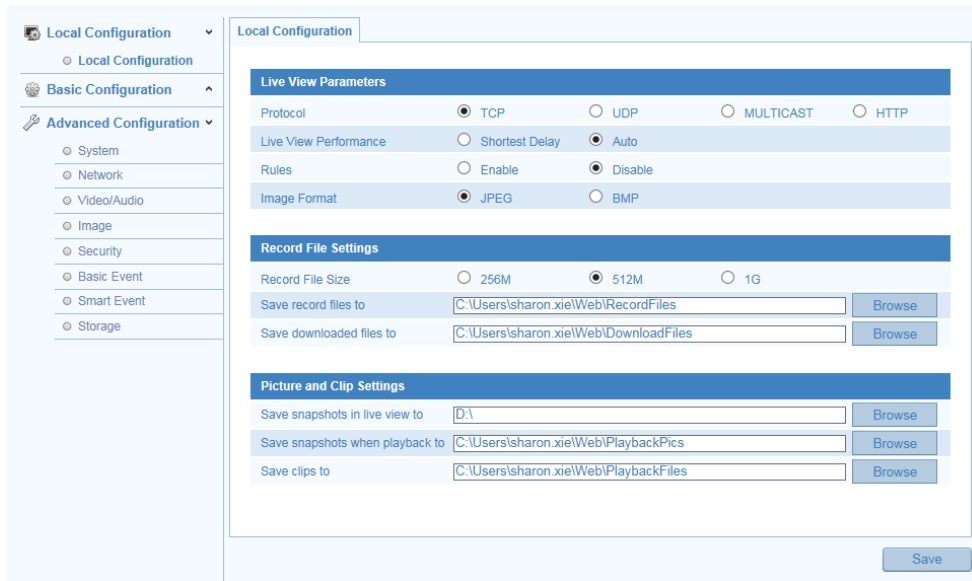

Figure 4-2 Local Configuration Interface

2. Configure the following settings:

- **Live View Parameters:** Set the protocol type, stream type, image size and live view performance.
 - ◆ **Protocol:** TCP, UDP, MULTICAST and HTTP are selectable.
 - TCP:** Ensures complete delivery of streaming data and better video quality, yet the real-time transmission will be affected.
 - UDP:** Provides real-time audio and video streams.
 - HTTP:** Allows the same quality as of TCP without setting specific ports for streaming under some network environments.
 - MULTICAST:** It's recommended to select the protocol type to Multicast when using the Multicast function. For other information about Multicast, refer to **Section 6.3.1 Configuring TCP/IP Settings**.
 - ◆ **Live View Performance:** Set the live view performance to Shortest Delay or Auto.
 - ◆ **Rules:** You can enable or disable the rules of dynamic analysis for events here.
 - ◆ **Image Format:** The captured pictures can be saved as different format. JPEG and BMP are available.
- **Record File Settings:** Set the saving path of the video files.
 - ◆ **Record File Size:** Select the packed size of manually recorded and downloaded video files. The size can be set to 256M, 512M or 1G.
 - ◆ **Save record files to:** Set the saving path for the manually recorded video files.
 - ◆ **Save downloaded files to:** Set the saving path for the downloaded video files in **Playback** interface.
- **Picture and Clip Settings:** Set the saving paths of the captured pictures and clipped video files.
 - ◆ **Save snapshots in live view to:** Set the saving path of the manually captured pictures in **Playback** interface.
 - ◆ **Save snapshots when playback to:** Set the saving path of the captured pictures in

Playback

interface.

- ◆ **Save clips to:** Set the saving path of the clipped video files in **Playback** interface.



You can click **Browse** to change the directory for saving video files, clips and pictures.

3. Click **Save** to save the settings.



4.3 Live View Page

Purpose:

The live video page allows you to view live video, capture images, realize PTZ control, set/call presets and configure video parameters.

Log in the network speed dome to enter the live view page, or you can click **Live View** on the menu bar of the main page to enter the live view page.

Descriptions of the live view page:

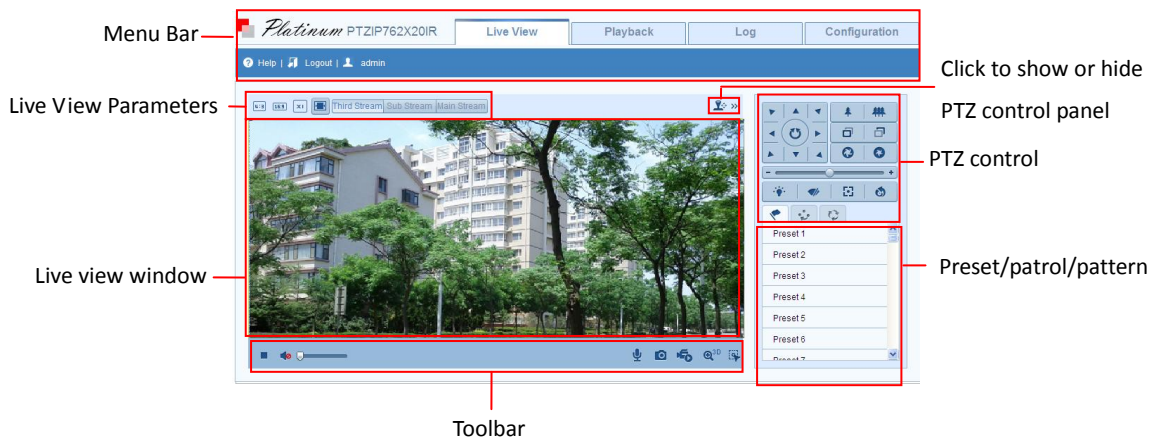

Figure 4-3 Live View Page

Menu Bar:

Click each tab to enter Live View, Playback, Log and Configuration page respectively.

Live View Window:

Display the live video.

Toolbar:

Operations on the live view page, e.g., live view, capture, record, audio on/off, two-way audio,

etc.

PTZ Control:

Panning, tilting, focusing and zooming actions of the speed dome. The lighter, wiper, one-touch focus and lens initialization control.

Preset/patrol/pattern:

Set and call the preset/patrol/pattern for the speed dome.

Live View Parameters:

Configure the image size and stream type of the live video.

4.4 Starting Live View











In the live view window as shown in Figure 4-4, click  on the toolbar to start the live view of the speed dome.

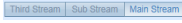
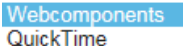

Figure 4-4 Start Live View

Table 4-1 Descriptions of the Toolbar

Icon	Description	Icon	Description
	Start/Stop Live view		Manually capture the pictures
	Display in 4:3/16:9/original/ Self-adaptive window size.		Live view with the main/sub/third stream.
	Play via webcomponents/ quick time.		Two-way audio off/on/
	Manual recording off/on		Mute / Audio on and adjust volume
	Start/Stop Manual Tracking		3D positioning



- Not all the speed dome models support the above functions. Please take the browser interface of the actual product as standard.
- Before enabling the two-way audio or recording with audio functions, please set the **Stream Type** to **Video & Audio** referring to Section **6.4.1 Configuring Video Settings**.
Before using the two-way audio or recording with audio functions, please set the **Stream Type** to **Video & Audio** referring to Section **6.4.1 Configuring Video Settings**.

Full-screen Mode:

You can double-click on the live video to switch the current live view into full-screen or return to normal mode from the full-screen.

3D Positioning:

Steps:



1. Click  on the tool bar of live view interface.
2. Operate the 3D positioning function:
 - Left click a position of the live video. The corresponding position will be moved to the center of the live video.
 - Hold down the left mouse button and drag the mouse to the lower right on the live video. The corresponding position will be moved to the center of the live video and zoomed in.
 - Hold down the left mouse button and drag the mouse to the upper left on the live video. The corresponding position will be moved to the center of the live video and zoomed out.



Please refer to the following sections for more information:

- Configuring remote recording in Section **7.2 Configuring Recording Schedule**.
- Setting the image quality of the live video in Section **6.1 Configuring Local Parameters** and Section **6.4.1 Configuring Video Settings**.
- Setting the OSD text on live video in Section **6.5.2 Configuring OSD Settings**.

4.5 Recording and Capturing Pictures Manually

In the live view interface, click  on the toolbar to capture the live pictures or click  to record the live video. The local saving paths of the captured pictures and clips can be set in the **Configuration > Local Configuration** interface.

To configure remote automatic recording, please refer to Section **7.2 Configuring Recording Schedule**.





You can configure the format of the picture to save in your computer as JPEG or BMP, refer to the **section 6.1 Configuring Local Parameters**.

4.6 Operating PTZ Control

Purpose:

In the live view interface, you can use the PTZ control buttons to control panning, tilting and zooming.

4.6.1 PTZ Control Panel

On the live view page, click  << to show the PTZ control panel or click  >> to hide it.

Click the direction buttons to control the pan/tilt movements.

Click the zoom/iris/focus buttons to realize lens control.

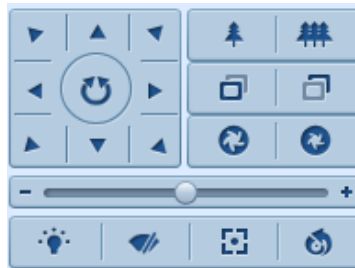



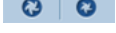







Figure 4-5 PTZ Control Panel

Table 4-2 Descriptions of PTZ Control Panel





Button	Description
	PTZ Control Panel
	Zoom in/out
	Focus near/far
	Iris Open/Close
	Adjust speed of pan/tilt movements
	Auxiliary Functions
	Preset
	Patrol
	Pattern

4.6.2 Auxiliary Functions

The Auxiliary functions panel is shown in the figure below:



Figure 4-6 Auxiliary Functions

-  Light
Click  to enable/disable the light supplement of the speed dome. This function is reserved.
-  Wiper
Click  to move the wiper once.
-  Auxiliary Focus
The auxiliary focus function is reserved.

4.6.3 Setting / Calling a Preset

Purpose:

A preset is a predefined image position. For the defined preset, you can click the calling button to quickly view the desired image position.

● **Setting a Preset:**

Steps:

1. In the PTZ control panel, select a preset number from the preset list.

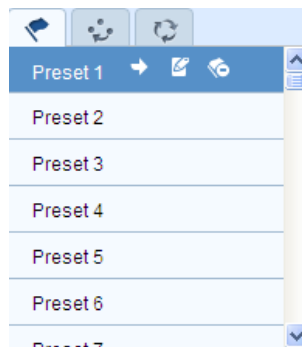



Figure 4-7 Setting a Preset

2. Use the PTZ control buttons to move the lens to the desired position.
 - Pan the speed dome to the right or left.
 - Tilt the speed dome up or down.

- Zoom in or out.
 - Refocus the lens.
3. Click  to finish the setting of the current preset.
 4. You can click  to delete the preset.



You can configure up to 256 presets.



● Calling a Preset:

In the PTZ control panel, select a defined preset from the list and click  to call the preset.

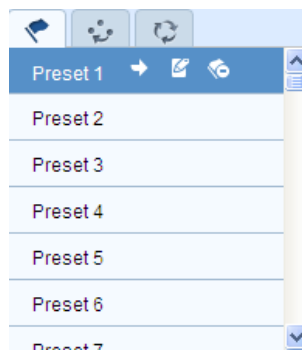

Figure 4-8 Calling a Preset

For convenient preset selection, refer to the following steps to navigate to the preset you want.

Steps:

1. Select any preset from the list.
2. Click the preset number you need on the keyboard.



The following presets are predefined with special commands. You can only call them but not configure them. For instance, preset 99 is the “Start auto scan”. If you call the preset 99, the speed dome starts auto scan function.

Table 4-3 Special Presets

Preset No.	Function	Preset No.	Function
33	Auto flip	93	Set limit stops manually
34	Back to initial position	94	Remote reboot
35	Call patrol 1	96	Stop a scan
36	Call patrol 2	97	Start random scan
37	Call patrol 3	98	Start frame scan
38	Call patrol 4	99	Start auto scan
39	IR cut filter in	100	Start tilt scan
40	IR cut filter out	101	Start panorama scan
41	Call pattern 1	102	Call patrol 5

Preset No.	Function	Preset No.	Function
42	Call pattern 2	103	Call patrol 6
43	Call pattern 3	104	Call patrol 7
44	Call pattern 4	105	Call patrol 8
45	One-touch patrol	106	Fan On
92	Start to set limit stops	107	Fan Off
		108	Fan On By Temperature Control

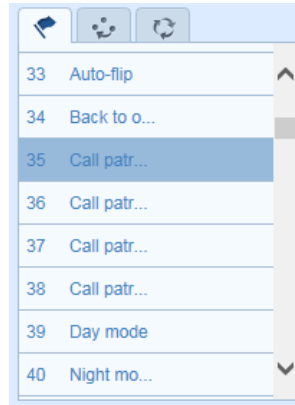

Figure 4-9 Special Preset



When you calling preset 45 (one-touch patrol), the speed dome patrols from the preset 1 to 32. Before you enable this function, please set the preset 1 to 32 first.

4.6.4 Setting / Calling a Patrol

Purpose:



A patrol is a memorized series of preset function. It can be configured and called on the patrol settings interface. There are up to 8 patrols for customizing. A patrol can be configured with 32 presets.

Before you start:

Please make sure that the presets you want to add into a patrol have been defined.

● **Setting a Patrol:**

Steps:

1. In the PTZ control panel, click  to enter the patrol settings interface.
2. Select a patrol number from .
3. Click  to enter the adding interface of preset as shown in Figure 4-10.

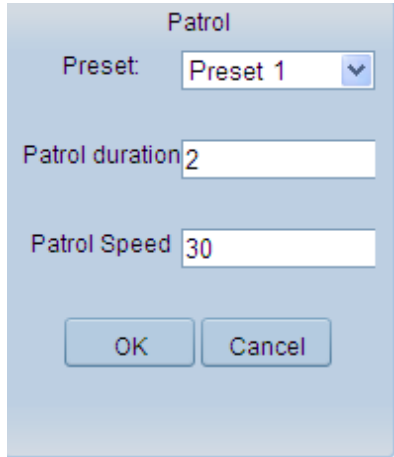
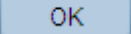



Figure 4-10 Adding Presets



- Configure the preset number, patrol time and patrol speed.

Name	Description
Patrol Time	It is the duration staying on one patrol point. The speed dome moves to another patrol point after the patrol time.
Patrol Speed	It is the speed of moving from one preset to another.

- Click  to save a preset into the patrol.
- Repeat the steps from 3 to 5 to add more presets.
- Click  to save all the patrol settings.

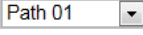

● **Calling a Patrol:**

In the PTZ control panel, select a defined patrol from  and click  to call the patrol as shown in Figure 4-11.

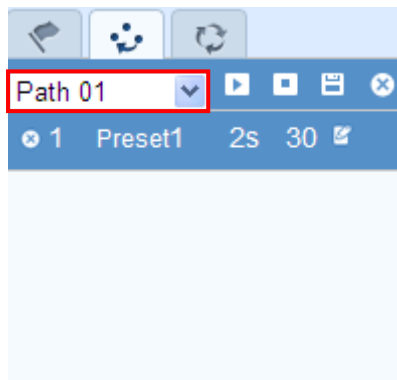









Figure 4-11 Calling a Preset

● **Buttons on the Patrols interface:**

Buttons	Description
	Save a patrol

	Call a patrol
	Stop a patrol
	Enter the adding interface of preset
	Modify a preset
	Delete a preset
	Delete all the presets in one patrol

4.6.5 Setting / Calling a Pattern

Purpose:

A pattern is a memorized series of pan, tilt, zoom, and preset functions. It can be called on the pattern settings interface. There are up to 4 patterns for customizing.

● **Setting a Pattern:**

Steps:



1. In the PTZ control panel, click  to enter the pattern settings interface.
2. Select a pattern number from the list as shown in Figure 4-12.







Figure 4-12 Patterns Settings Interface

3. Click  to enable recording the panning, tilting and zooming actions.
4. Use the PTZ control buttons to move the lens to the desired position after the information of **PROGRAM PATTERN REMAINNING MEMORY(%)** is displayed on the screen.
 - Pan the speed dome to the right or left.
 - Tilt the speed dome up or down.
 - Zoom in or out.
 - Refocus the lens.
5. Click  to save all the pattern settings.



● **Buttons on the Patterns interface:**

Buttons	Description
	Start to record a pattern.
	Stop recording a pattern.
	Call the current pattern.

	Stop the current pattern.
	Delete the current pattern.



- These 4 patterns can be operated separately and with no priority level.
- When configuring and calling the pattern, proportional pan is valid; the limit stops and auto flip will be invalid; and the 3D positioning operation is not supported.

4.7 Configuring Live View Parameters

- **Main stream/Sub-stream:**

You can select or as the stream type of live viewing. The main stream is with a relatively high resolution and needs much bandwidth. The sub-stream is with a low resolution and needs less bandwidth. The default setting of stream type is .



Please refer to Section **6.4.1 Configuring Video Settings** for more detailed parameter settings of the main stream and sub-stream respectively.

- **Image Size:**

You can scale up/down the live view image by clicking . the image size can be 4:3, 16:9, original or auto.

Chapter 5 System Configurations

5.1 Storage Settings

Before you start:

To configure record settings, please make sure that you have the network storage device within the network or the storage card has been inserted in the corresponding card slot. Refer to the installation guide for the location of the storage card slot.

5.1.1 Configuring Recording Schedule

Before you start:

Please make sure a local storage card is inserted in the speed dome or the network storage is added to the speed dome, and the

Purpose:

There are two kinds of recording for the speed domes: manual recording and scheduled recording. In this section, you can follow the instructions to configure the scheduled recording. By default, the record files of scheduled recording are stored in the SD card (if supported) or in the network disk.

Steps:

1. Enter the Record Schedule Settings interface:

Configuration > Storage > Schedule Settings > Record Schedule

Pre-record: 5s

Post-record: 5s

Overwrite: Yes

Recording Stream: Main Stream

Enable Record Schedule

Edit

	0	2	4	6	8	10	12	14	16	18	20	22	24
Mon													
Tue													
Wed													
Thu													
Fri													
Sat													
Sun													

- Continuous
- Motion Detection
- Alarm
- Motion | Alarm
- Motion & Alarm
- Other

Figure 5-1 Recording Schedule Interface

2. Check the checkbox of **Enable** to enable scheduled recording.

3. To set the advanced settings of the speed dome.

Pre-record	5s
Post-record	5s
Overwrite	Yes
Recording Stream	Main Stream

Figure 5-2 Record Parameters

- **Pre-record:** The time you set to start recording before the scheduled time or the event. For example, if an alarm triggers recording at 10:00, and the pre-record time is set as 5 seconds, the speed dome starts to record at 9:59:55. The Pre-record time can be configured as No Pre-record, 5 s, 10 s, 15 s, 20 s, 25 s, 30 s or not limited.



The pre-record time changes according to the video bitrate.

- **Post-record:** The time you set to stop recording after the scheduled time or the event. For example, if an alarm triggered recording ends at 11:00, and the post-record time is set as 5 seconds, the speed dome records until 11:00:05. The Post-record time can be configured as 5 s, 10 s, 30 s, 1 min, 2 min, 5 min or 10 min.



The Pre-record and Post-record parameters vary depending on the speed dome model.

- **Overwrite:** If you enable this function and the HDD is full, the new record files overwrite the oldest record files automatically.
 - **Recording Stream:** You can select the stream type for recording; Main stream and Sub Stream are selectable. If you select the sub stream, you can record for a longer time with the same storage capacity.
4. Click **OK** to save the setting.

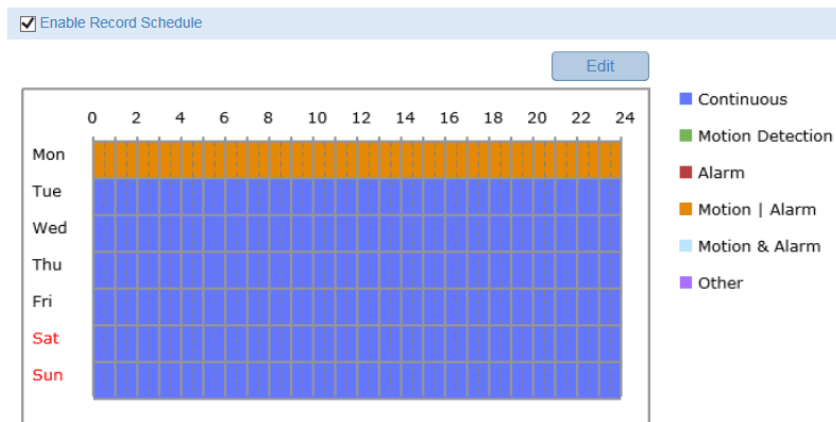

Figure 5-3 Record Schedule

5. Set the record schedule:

- (1) Select a **Record Type**. The record type can be Continuous, Motion Detection, Alarm, Motion | Alarm, Motion & Alarm, Face Detection, Intrusion Detection, Line Crossing Detection, Audio Exception Detection and All events.
 - ◆ **Continuous**

If you select **Continuous**, the video will be recorded automatically according to the time of the schedule.
 - ◆ **Record Triggered by Motion Detection**

If you select **Motion Detection**, the video will be recorded when the motion is detected. Besides configuring the recording schedule, you have to set the motion detection area and check the checkbox of **Trigger Channel** in the **Linkage Method** of Motion Detection Settings interface.
 - ◆ **Record Triggered by Alarm**

If you select **Alarm**, the video will be recorded when the alarm is triggered via the external alarm input channels. Besides configuring the recording schedule, you have to set the **Alarm Type** and check the checkbox of **Trigger Channel** in the **Linkage Method** of **Alarm Input Settings** interface..
 - ◆ **Record Triggered by Motion & Alarm**

If you select **Motion & Alarm**, the video will be recorded when the motion and alarm are triggered at the same time. Besides configuring the recording schedule, you have to configure the settings on the **Motion Detection** and **Alarm Input Settings** interfaces.
 - ◆ **Record Triggered by Motion | Alarm**

If you select **Motion | Alarm**, the video will be recorded when the external alarm is triggered or the motion is detected. Besides configuring the recording schedule, you have to configure the settings on the **Motion Detection** and **Alarm Input Settings** interfaces.
 - ◆ **Record Triggered by Audio Exception Detection**

If you select **Audio Exception Detection**, the video will be recorded when the audio exception is detected. Besides configuring the recording schedule, you have to configure the settings on the **Audio Exception Detection** interface.
 - ◆ **Record Triggered by Other Smart Events**

The smart events include Line Crossing Detection, Intrusion Detection, Region Entrance Detection and Region Exiting Detection. If you select to record by one type of the smart events, the video will be recorded when the selected smart event is triggered. Besides configuring the recording schedule, you have to configure the settings on the specific event settings interface.
 - ◆ **Record Triggered by All Events**

If you select **All Events**, the video will be recorded when any event is detected.
- (2) Select the timeline of a certain day, click and drag the left button of the mouse to set the recording schedule (the start time and end time of the recording task).
- (3) After you set the scheduled task, you can click  and copy the task to other days

(optional).

- (4) After setting the record schedule, you can click a record segment to display the segment record settings interface to edit the segment record parameters. (optional)

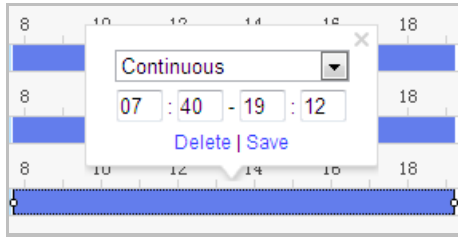

Figure 5-4 Segment Record Settings



The time of each segment cannot be overlapped. Up to 8 segments can be configured for each day.

6. Click  to save the settings.

5.1.2 Configuring Net HDD

Before you start:

The network disk should be available within the network and properly configured to store the recorded files, log files, etc.

Steps:

Add Net HDD

1. Enter the NAS (Network-Attached Storage) Settings interface:

Configuration > Storage > NAS

HDD No.	Type	Server Address	File Path
1	NAS	<input type="text"/>	<input type="text"/>
Mounting Type: <input type="text" value="NFS"/> User Name: <input type="text"/> Password: <input type="text"/> <input type="button" value="Test"/>			
2	NAS		
3	NAS		
4	NAS		
5	NAS		
6	NAS		
7	NAS		
8	NAS		

Figure 5-5 Select Net HDD Type

2. Enter the IP address and the file path of the network disk.
3. Select the mounting type. NFS and SMB/CIFS are selectable. You can set the user name and password to guarantee the security if SMB/CIFS is selected.



Please refer to the *NAS User Manual* for creating the file path.



- *For your privacy and to better protect your system against security risks, we strongly recommend the use of strong passwords for all functions and network devices. The password should be something of your own choosing (Using a minimum of 8 characters, including at least three of the following categories: upper case letters, lower case letters, numbers, and special characters.) in order to increase the security of your product.*
 - *Proper configuration of all passwords and other security settings is the responsibility of the installer and/or end-user.*
4. Click  to save the settings.

5.1.3 Configuring Snapshot Settings

Purpose:

You can configure the scheduled snapshot and event-triggered snapshot. You can upload the captured pictures to a FTP server.

Basic Settings

Steps:

1. Enter the Snapshot Settings interface:
Configuration > Advanced Configuration > Storage > Snapshot
2. Check the **Enable Timing Snapshot** checkbox to enable continuous snapshot. Check the **Enable Event-triggered Snapshot** checkbox to check event-triggered snapshot.
3. Select the quality of the snapshot.
4. Set the time interval between two snapshots.
5. Click  to save the settings.

Uploading to FTP



Please make sure that the FTP server is online.

You can follow below configuration instructions to upload the snapshots to FTP.

- Upload continuous snapshots to FTP

Steps:

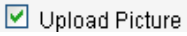
- 1) Configure the FTP settings and check  checkbox in FTP Settings interface. Please refer to Section **6.3.8 Configuring FTP Settings** for more details to configure FTP parameters.
- 2) Check the **Enable Timing Snapshot** checkbox.
- 3) Click **Edit** to set the snapshot schedule.

- Upload event-triggered snapshots to FTP

Steps:

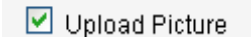
- 1) Configure the FTP settings and check  checkbox in FTP Settings interface. Please refer to Section **6.3.8 Configuring FTP Settings** for more details to configure FTP parameters.

- 2) Check Upload to FTP checkbox in Motion Detection Settings or Alarm Input interface.
- 3) Check the **Enable Event-triggered Snapshot** checkbox.

The screenshot displays two configuration sections for snapshots:

Timing

- Enable Timing Snapshot
- Format: JPEG
- Resolution: 704*480
- Quality: High
- Interval: 0 millisecond

Event-Triggered

- Enable Event-Triggered Snapshot
- Format: JPEG
- Resolution: 704*480
- Quality: High
- Interval: 0 millisecond
- Capture Number: 4

Below the Timing section is a calendar grid for scheduling snapshots. The grid has columns for hours (2, 4, 6, 8, 10, 12, 14, 16, 18, 20, 22, 24) and rows for days of the week (Mon, Tue, Wed, Thu, Fri, Sat, Sun). The grid is currently empty, indicating no scheduled snapshots.

Figure 5-6 Snapshot Settings

5.2 Basic Event Configuration

Purpose:

This section explains how to configure the network speed dome to respond to alarm events, including motion detection, external alarm input, video loss, tamper-proof and exception. These events can trigger the alarm actions, such as Notify Surveillance Center, Send Email, Trigger Alarm Output, etc.

For example, when an external alarm is triggered, the network speed dome sends a notification to an e-mail address.

5.2.4 Configuring Motion Detection

Purpose:

Motion detection is a feature which can trigger alarm actions and actions of recording videos when the motion occurred in the surveillance scene.

Steps:

1. Enter the motion detection setting interface:
Configuration > Event > Basic Event > Motion Detection

2. Check the checkbox of the **Enable Motion Detection** to enable this function.
You can check the **Enable Dynamic Analysis for Motion** checkbox if you want the detected object get marked with rectangle in the live view.
3. Select the configuration mode as Normal or Expert and set the corresponding motion detection parameters.
 - **Normal**

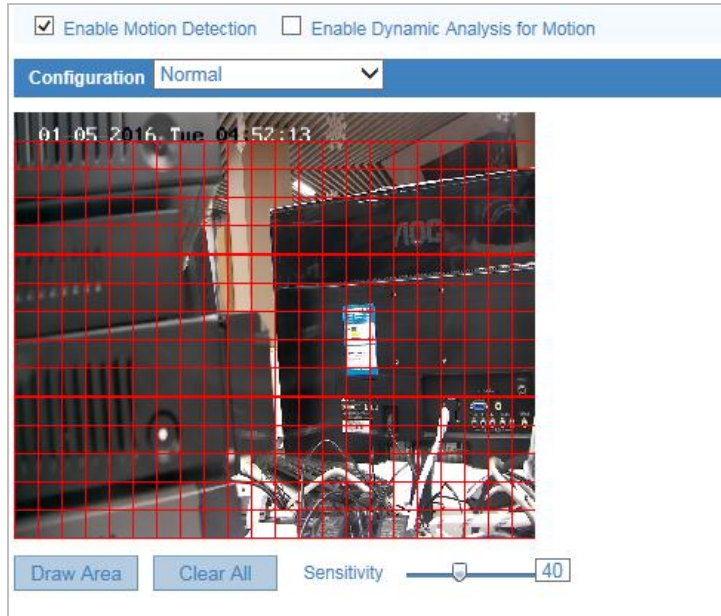

Figure 5-7 Motion Detection Settings-Normal

Steps:

- (1) **Draw Area**. Click and drag the mouse on the live video image to draw a motion detection area.
- (2) Click **Stop Draw...** to finish drawing.



- You can draw up to 8 motion detection areas on the same image.
 - You can click **Clear All** to clear all of the areas.
- (3) Move the slider **Sensitivity** to set the sensitivity of the detection.
- **Expert**

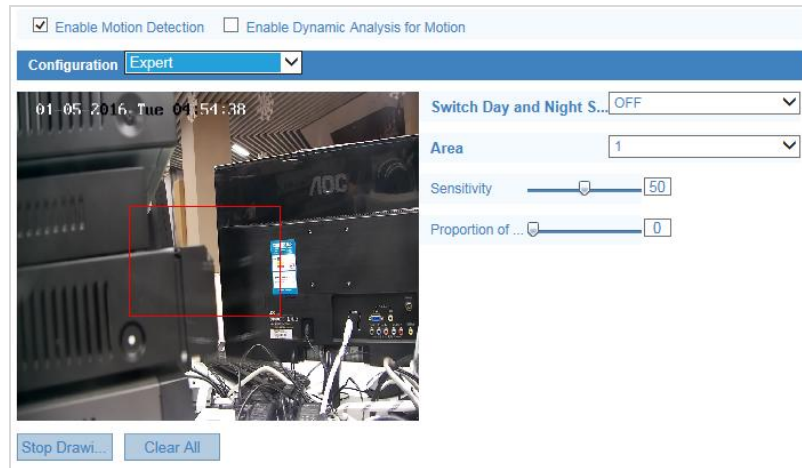

Figure 5-8 Motion Detection Settings-Expert

Steps:

- (1) Set the Day&Night switch mode, there are OFF, Auto-Switch and Scheduled-Switch selectable. If the Day&Night switch mode is enabled, you can configure the detection rule for the day and night separately.

OFF: Disable the day and night switch.

Auto-Switch: Switch the day and night mode according to the illumination automatically.

Scheduled-Switch: Switch to the day mode at 6:00 a.m., and switch to the night mode at 18:00 p.m..

- (2) Select Area No. to configure in the dropdown list.
- (3) Set the values of sensitivity and proportion of object on area.

Sensitivity: The greater the value is, the easier the alarm will be triggered.

Proportion of Object on Area: When the size proportion of the moving object exceeds the predefined value, the alarm will be triggered. The less the value is, the easier the alarm will be triggered.

4. Set the Arming Schedule for Motion Detection.

- (1) Click **Arming Schedule** tab to enter the arming schedule setting interface.

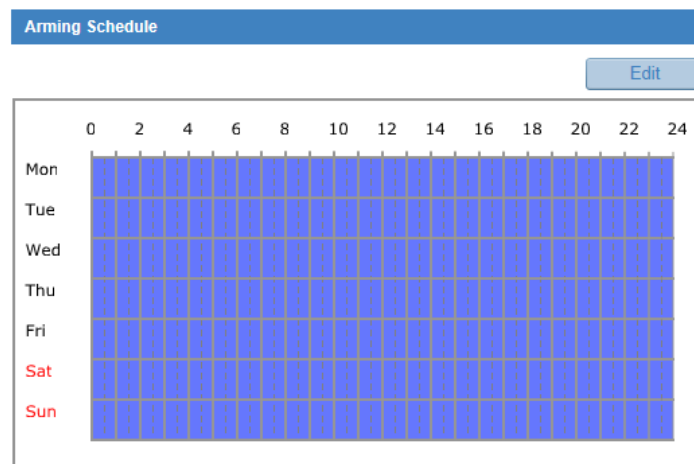



Figure 5-9 Arming Schedule

- (2) Select the timeline of a certain day, click and drag the mouse to set the arming schedule (the start time and end time of the arming task).
- (3) After you set the scheduled task, you can click  and copy the task to other days (optional).

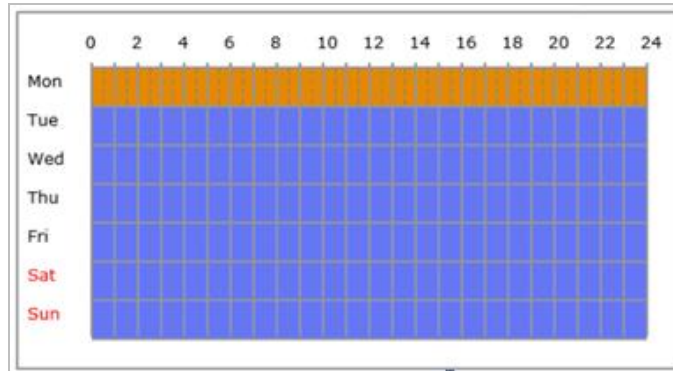

Figure 5-10 Arming Time Schedule

- (4) After setting the arming schedule, you can click a segment to display the segment arming settings interface to edit the segment record parameters (optional).

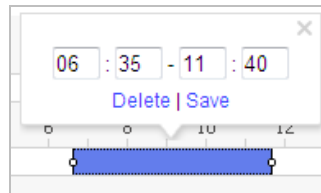

Figure 5-11 Segment Arming Settings

- (5) Click  to save the settings.



The time of each period cannot be overlapped. Up to 8 periods can be configured for each day.

5. Set the Alarm Actions for Motion Detection.

Click  tab to enter the **Linkage Method** interface.

You can specify the linkage method when an event occurs. The following contents are about how to configure the different types of linkage method.

Linkage Method	
Normal Linkage	Other Linkage
<input checked="" type="checkbox"/> Notify Surveillance Center <input type="checkbox"/> Send Email <input type="checkbox"/> Upload to FTP <input type="checkbox"/> Trigger Channel	Trigger Alarm Output <input type="checkbox"/> Select All <input type="checkbox"/> A->1 <input type="checkbox"/> A->2

Figure 5-12 Linkage Method

Check the checkbox to select the linkage method. Notify surveillance center, send email, upload to FTP, trigger channel and trigger alarm output are selectable.

- **Notify Surveillance Center**

Send an exception or alarm signal to remote management software when an event occurs.

- **Send Email**

Send an email with alarm information to a user or users when an event occurs.



To send the Email when an event occurs, you need to refer to **Section 6.3.11 Configuring Email Settings** to set the Email parameters.

- **Upload to FTP**

Capture the image when an alarm is triggered and upload the picture to a FTP server.



You need a FTP server and set FTP parameters first. Refer to **Section 6.3.8 Configuring FTP Settings** for setting FTP parameters.

- **Trigger Channel**

Record a video when an event occurs.



You have to set the recording schedule to realize this function..

- **Trigger Alarm Output**

Trigger one or more external alarm outputs when an event occurs.

5.2.5 Configuring Video Loss Alarm

Steps:

1. Enter the Video Loss Setting interface:

Configuration > Event > Basic Event > Video Loss

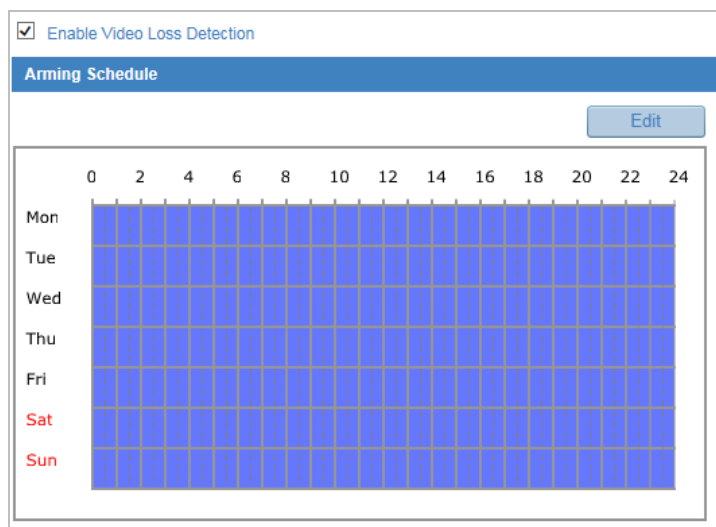

Figure 5-13 Video Loss

2. Check the **Enable** checkbox to enable the video loss detection.
3. Click **Arming Schedule** tab to enter the arming schedule setting interface. The arming schedule configuration is the same as the setting of the arming schedule for motion

detection.

- Click **Linkage Method** tab to select the linkage method taken for the video loss alarm, notify surveillance center, send email and trigger alarm output are selectable.
- Click **Save** to save the settings.

5.2.6 Configuring Video Tampering Alarm

Purpose:

You can configure the speed dome to trigger the alarm actions when the lens is covered.

Steps:

- Enter the video tampering Settings interface:

Configuration > Event > Basic Event > Video Tampering



Figure 5-14 Tampering Alarm

- Check **Enable** checkbox to enable the tampering detection.
- Set the tampering area.
- Click **Arming Schedule** tab to enter the arming schedule setting interface. The arming schedule configuration is the same as the setting of the arming schedule for motion detection.
- Click **Linkage Method** tab to select the linkage method taken for the video loss alarm, including Notify surveillance center, send email, trigger channel, smart tracking and trigger alarm output are selectable.
- Click **Save** to save the settings.

5.2.7 Configuring Alarm Input

Steps:

1. Enter the Alarm Input Settings interface:
Configuration > Event > Basic Event > Alarm Input
2. Choose the alarm input No. and the Alarm Type. The alarm type can be NO (Normally Open) and NC (Normally Closed).
3. Edit the name in (cannot copy) to set a name for the alarm input (optional).

The screenshot shows the 'Alarm Input Settings' interface. At the top, there are three dropdown menus: 'Alarm Input No.' with the value 'A<-1', 'Alarm Name' with the text '(cannot copy)', and 'Alarm Type' with the value 'NO'. Below these is a section titled 'Arming Schedule' with a blue header and an 'Edit' button. The main part of the interface is a 24-hour grid for each day of the week. The days are listed on the left: Mon, Tue, Wed, Thu, Fri, Sat, and Sun. The hours are listed at the top: 0, 2, 4, 6, 8, 10, 12, 14, 16, 18, 20, 22, 24. Each cell in the grid contains a small icon representing the arming status for that specific day and time.

Figure 5-15 Alarm Input Settings

4. Click **Arming Schedule** tab to enter the arming schedule setting interface. The arming schedule configuration is the same as the setting of the arming schedule for motion detection..
5. Click **Linkage Method** tab to select the linkage method taken for the video loss alarm, including Notify surveillance center, send email, trigger channel, smart tracking and trigger alarm output are selectable.
6. You can also choose the PTZ linking for the alarm input. Check the relative checkbox and select the No. to enable Preset Calling, Patrol Calling or Pattern Calling.
7. You can copy your settings to other alarm inputs.
8. Click **Save** to save the settings.

Figure 5-16 Linkage Method

5.2.8 Configuring Alarm Output

Steps:

1. Enter the Alarm Output Settings interface:
Configuration > Event > Basic Event > Alarm Output
2. Select one alarm output channel in the **Alarm Output** drop-down list.
3. Set a name in (cannot copy) for the alarm output (optional).
4. The **Delay** time can be set to **5sec, 10sec, 30sec, 1min, 2min, 5min, 10min** or **Manual**. The delay time refers to the time duration that the alarm output remains in effect after alarm occurs.
5. Click **Arming Schedule** tab to enter the arming schedule setting interface. The time schedule configuration is the same as the settings of the arming schedule for motion detection.

Figure 5-17 Alarm Output Settings

- You can copy the settings to other alarm outputs.
- Click to save the settings.

5.2.9 Handling Exception

The exception type can be HDD full, HDD error, network disconnected, IP address conflicted and illegal login to the speed domes.

Steps:

- Enter the Exception Settings interface:
Configuration > Event > Basic Event > Exception
- Check the checkbox to set the actions taken for the Exception alarm.

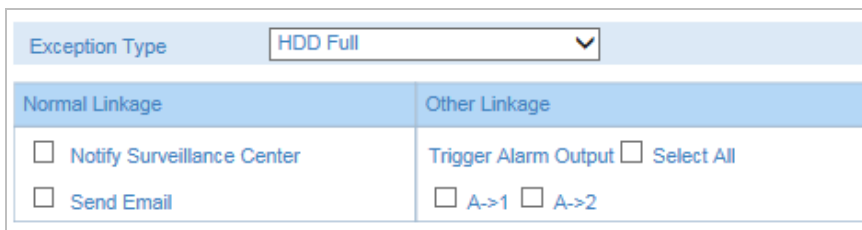

Exception Type: HDD Full	
Normal Linkage	Other Linkage
<input type="checkbox"/> Notify Surveillance Center	Trigger Alarm Output <input type="checkbox"/> Select All
<input type="checkbox"/> Send Email	<input type="checkbox"/> A->1 <input type="checkbox"/> A->2

Figure 5-18 Exception Settings

- Click to save the settings.

5.3 Smart Event Configuration

5.3.1 Detecting Audio Exception

Purpose:

When you enable this function and audio exception occurs, the alarm actions will be triggered.

Steps:

- Enter the video audio exception detection interface:
Configuration > Event > Smart Event > Audio Exception Detection

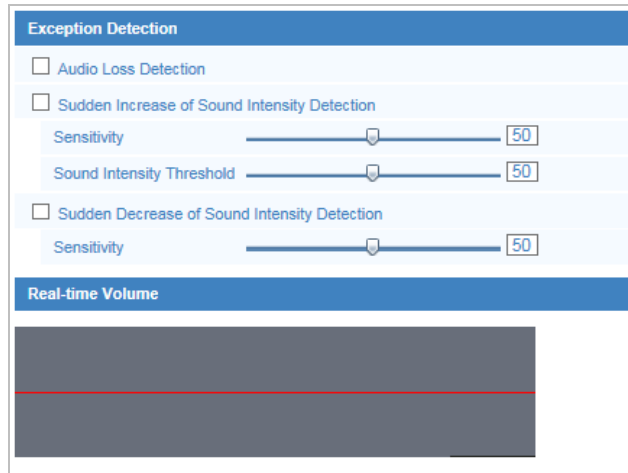

Figure 5-19 Audio Exception Detection

2. Check the checkbox of **Audio Loss Detection** to enable the audio input exception detection.
3. Check the checkbox of **Sudden Increase of Sound Intensity Detection** checkbox to enable the sudden rise detection.
 - **Sensitivity**: Range [1-100], the smaller the value the more severe the sound change will trigger the detection.
 - **Sound Intensity Threshold**: Range [1-100], it can filter the sound in the environment, the louder the environment sound, the higher the value should be. You can adjust it according to the actual environment.
4. Check the checkbox of **Sudden Decrease of Sound Intensity Detection** checkbox to enable the sudden drop detection.

Sensitivity: Range [1-100], the smaller the value the more severe the sound change will trigger the detection.
5. Click **Arming Schedule** tab to enter the arming schedule setting interface. The time schedule configuration is the same as the settings of the arming schedule for motion detection.
6. Click **Linkage Method** tab to select the linkage method taken for the video loss alarm, Notify surveillance center, send email, trigger channel, smart tracking and trigger alarm output are selectable.
7. Click **Save** to save the settings.

5.3.2 Configuring Intrusion Detection

Intrusion detection can set an area in the surveillance scene and once the area is entered, a set of alarm action is triggered.

Steps:

1. Enter the intrusion detection interface:

Configuration > Events > Smart Event > Intrusion Detection
2. Check the **Enable** checkbox to enable the intrusion detection function.

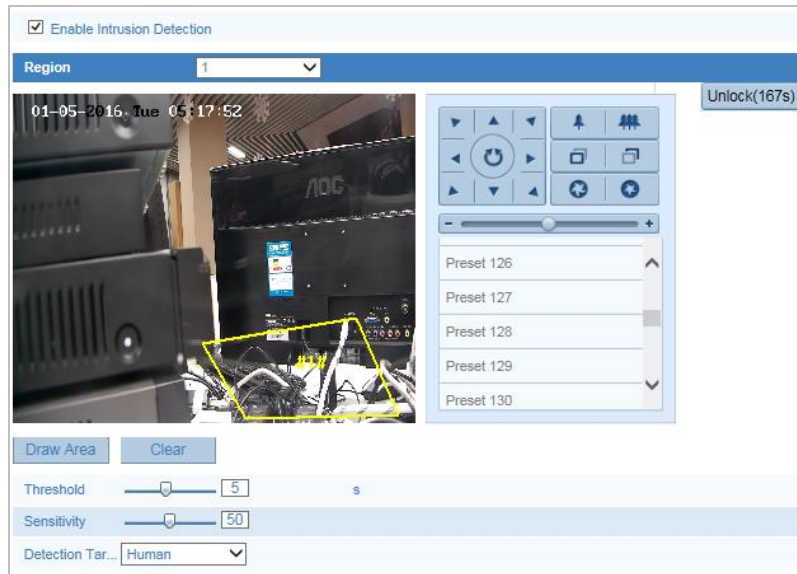

Figure 5-20 Configuring Intrusion Area

3. The event triggered and park action related PTZ movement will be locked for 180 seconds after you enter the intrusion detection interface. Optionally, you can click the **Unlock(134s)** button to manually activate the movement, or lock the movement when the button turns to **Lock** by clicking it.
4. Draw area.
 - 1) Select the Region No.in dropdown list.
 - 2) Click **Draw Area** to draw a rectangle on the image as a defense region.
 - 3) Click on the image to specify a corner of the rectangle, and right-click the mouse after four corners are configured.



Up to four areas are supported.

You can click **Clear** to clear the areas you drawn.

5. Configure the parameters for each defense region separately.
 - **Threshold:** Range [0-10s], the threshold for the time of the object staying in the region. If you set the value as 0, alarm is triggered immediately after the object entering the region.
 - **Sensitivity:** Range [1-100]. The value of the sensitivity defines the size of the object which can trigger the alarm, when the sensitivity is high, a very small object can trigger the alarm.
 - **Detection Target:** You can select human, vehicle, or all (human &vehicle) as the detection target from the dropdown list. If Human is selected, only human beings will be identified as detection objects and as well as Vehicle.
6. Click **Arming Schedule** tab to enter the arming schedule setting interface. The time schedule configuration is the same as the settings of the arming schedule for motion detection.
7. Click **Linkage Method** tab to select the linkage method taken for the video loss alarm, Notify

surveillance center, send email, trigger channel, smart tracking and trigger alarm output are selectable.

8. Click  to save the settings.

5.3.3 Configuring Line Crossing Detection

The virtual plane detection can be adopted for the intrusion detection. Once the virtual plane is detected being traversed according to the configured direction, a set of alarm action is triggered.

Steps:

1. Enter the Line Crossing Detection interface:

Configuration >Event > Smart Event > Line Crossing Detection

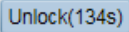
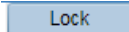
2. Check the **Enable** checkbox to enable the line crossing detection function.
3. Select the Line in dropdown list to configure.
4. The event triggered and park action related PTZ movement will be locked for 180 seconds after you enter the line crossing detection interface. Optionally, you can click the  button to manually activate the movement, or lock the movement when the button turns to  by clicking it.

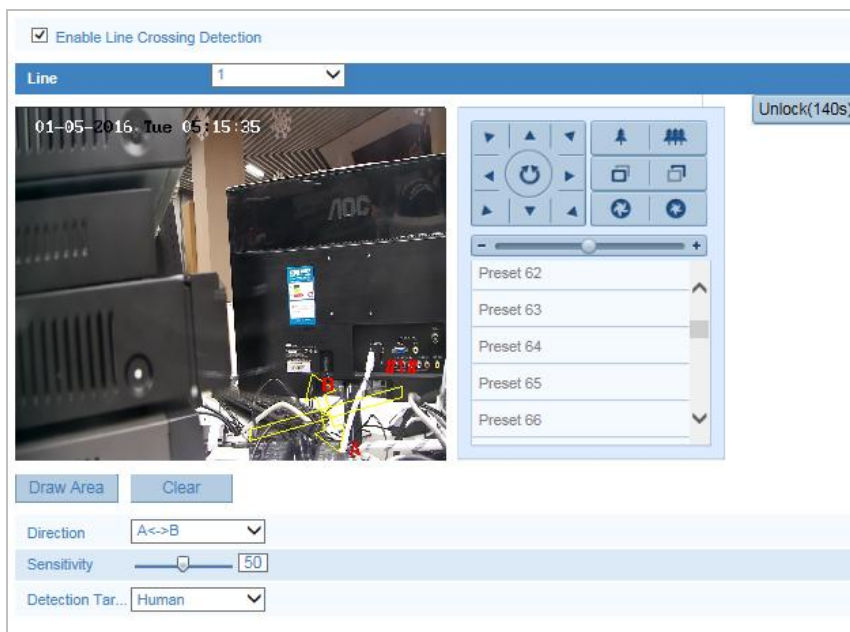
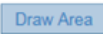

Figure 5-21 Configuring Line

5. Draw area.

- 1) Click  to draw a line on the image.
- 2) Click the line to switch to the editing mode.

Click and drag an end to the desired place to adjust the length and angle of the line. And

click and drag the line to adjust the location.



Up to four lines are supported.

6. Configure the parameters for each defense region separately.
 - **Direction:** Select the detection direction in the dropdown list, there are A<->B, A->B and B->A selectable.
 - **Sensitivity:** Range [1-100]. The value of the sensitivity defines the size of the object which can trigger the alarm, when the sensitivity is high, a very small object can trigger the alarm.
 - **Detection Target:** You can select human, vehicle, or all (human &vehicle) as the detection target from the dropdown list. If Human is selected, only human beings will be identified as detection objects and as well as Vehicle.
7. Click **Arming Schedule** tab to enter the arming schedule setting interface. The time schedule configuration is the same as the settings of the arming schedule for motion detection.
8. Click **Linkage Method** tab to select the linkage method taken for the video loss alarm, including Notify surveillance center, send email, upload to FTP, trigger channel, smart tracking and trigger alarm output are selectable.
9. Click **Save** to save the settings.

5.3.4 Region Entrance Detection

Purpose:

Region entrance detection function detects people, vehicle or other objects which enter a pre-defined virtual region from the outside place, and some certain actions can be taken when the alarm is triggered.

Steps:

1. Enter the Region Entrance Detection settings interface:
Configuration > Event > Smart Event > Region Entrance Detection
2. Check the checkbox of **Enable** to enable the Region Entrance Detection function.

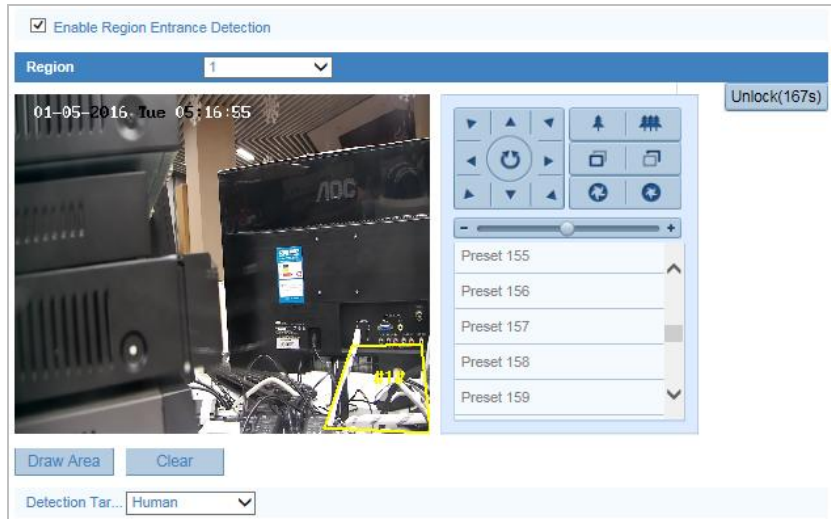

Figure 5-22 Configuring Region Entrance Detection

3. Select the region from the dropdown list for detection settings.
4. Click the **Draw Area** button to start the region drawing.
5. Click on the live video to specify the four vertexes of the detection region, and right click to complete drawing.
Repeat the step to configure other regions. Up to 4 regions can be set. You can click the **Clear** button to clear all pre-defined regions.
6. Set the detection target for the region entrance detection. You can select human, vehicle, or all (human & vehicle) as the detection target from the dropdown list. If Human is selected, only human beings will be identified as detection objects and as well as Vehicle.
7. Click **Arming Schedule** tab to enter the arming schedule setting interface. The time schedule configuration is the same as the settings of the arming schedule for motion detection.
8. Click **Linkage Method** tab to select the linkage method taken for the video loss alarm, Notify surveillance center, send email, upload to FTP, trigger channel, smart tracking and trigger alarm output are selectable.
9. Click **Save** to save the settings.

5.3.5 Region Exiting Detection

Purpose:

Region exiting detection function detects people, vehicle or other objects which exit from a pre-defined virtual region, and some certain actions can be taken when the alarm is triggered.

Steps:

1. Enter the Region Exiting Detection settings interface:
Configuration > Event > Smart Event > Region Exiting Detection
2. Check the checkbox of **Enable** to enable the Region Exiting Detection function.

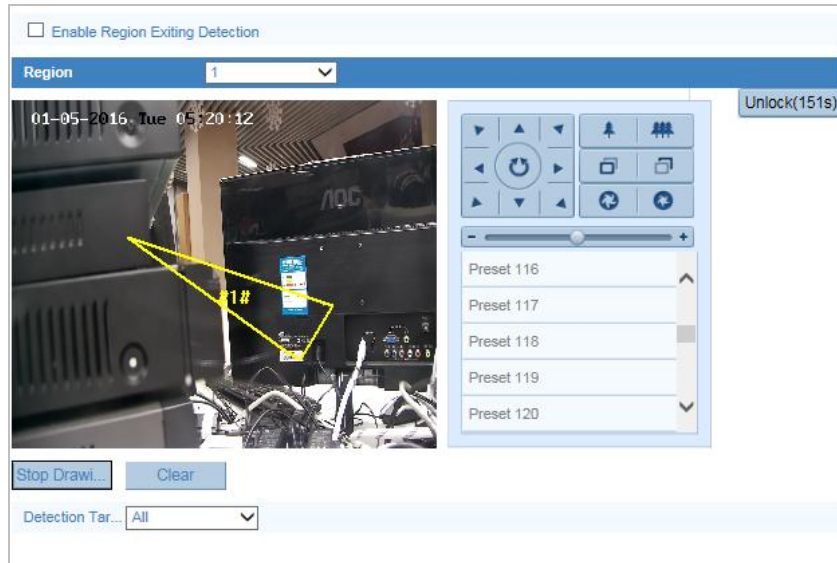

Figure 5-23 Configuring Region Exiting Detection

3. Select the region from the dropdown list for detection settings.
4. Click the **Draw Area** button to start the region drawing.
5. Click on the live video to specify the four vertexes of the detection region, and right click to complete drawing.
Repeat the step to configure other regions. Up to 4 regions can be set. You can click the **Clear** button to clear all pre-defined regions.
6. Set the detection target for the region entrance detection. You can select human, vehicle, or all (human & vehicle) as the detection target from the dropdown list. If Human is selected, only human beings will be identified as detection objects and as well as Vehicle.
7. Click **Arming Schedule** tab to enter the arming schedule setting interface. The time schedule configuration is the same as the settings of the arming schedule for motion detection.
8. Click **Linkage Method** tab to select the linkage method taken for the video loss alarm, Notify surveillance center, send email, upload to FTP, trigger channel, smart tracking and trigger alarm output are selectable.
9. Click **Save** button to save the settings.

5.4 PTZ Configuration

5.4.1 Configuring Initial Position

Purpose:

The initial position is the origin of PTZ coordinates. It can be the factory default initial position. You can also customize the initial position according to your own demand.

- **Customize an Initial Position:**

Steps:

1. Enter the Initial Position Configuration interface:
Configuration > Advanced Configuration > PTZ > Initial Position



Figure 5-24 PTZ Configuration

2. Click the PTZ control buttons to find a position as the initial position of the dome; you can also call a defined preset and set it as the initial position of the dome.
3. Click **Set** to save the position.



- **Call/delete an Initial Position:**

You can click to call the initial position. You can click to delete the initial position and restore the factory default initial position.

5.4.2 Configuring Basic PTZ Parameters

Purpose:

You can configure the basic PTZ parameters, including proportional pan, preset freezing, preset speed, etc.

1. Enter the Basic PTZ Parameter Configuration interface:
Configuration > Advanced Configuration > PTZ > Basic

Basic Parameter	
<input checked="" type="checkbox"/>	Enable Proportional Pan
<input type="checkbox"/>	Enable Preset Freezing
Preset Speed	4
Keyboard Control Speed	Normal
Auto Scan Speed	28
Zooming Speed	3
Manual Control Speed	Compatible

PTZ OSD	
Zoom Status	2s
PT Status	2s
Preset Status	2s

Power Off Memory	
Set Resume Time Point	30s

Figure 5-25 Basic PTZ Configuration Interface

2. Configure the following settings:

- **Basic Parameters:** Enable/disable proportional pan and preset freezing, set the preset speed, keyboard control speed, and auto scan speed.
 - ◆ **Proportional Pan:** If you enable this function, the pan/tilt speeds change according to the amount of zoom. When there is a large amount of zoom, the pan/tilt speed will be slower for keeping the image from moving too fast on the live view image.
 - ◆ **Preset Speed:** You can set the speed of a defined preset from 1 to 8.
 - ◆ **Keyboard Control Speed:** Define the speed of PTZ control by a keyboard as Low, Normal or High.
 - ◆ **Auto Scan Speed:** The dome provides 5 scan modes: auto scan, tilt scan, frame scan, random scan and panorama scan. The scan speed can be set from level 1 to 40.
 - ◆ **Zooming Speed:** The speed of zooming is adjustable.
 - ◆ **Manual Control Speed:** The manual control speed can be set as Compatible, Pedestrian, Non-motor Vehicle, Motor Vehicle or Self-adaptive.
 - Compatible: The control speed is same as the Keyboard Control Speed.
 - Pedestrian: Choose the **Pedestrian** when you monitor the pedestrians.
 - Non-motor Vehicle: Choose the **Non-motor Vehicle** when you monitor the non-motor vehicles.
 - Motor Vehicle: Choose the **Motor Vehicle** when you monitor the motor vehicles.
 - Self-adaptive: You are recommended to set the Self-adaptive when the application scene of the speed dome is complicated.
- **PTZ OSD:** Set the on-screen display duration of the PTZ status.
 - ◆ **Zoom Status:** Set the OSD duration of zooming status as 2 seconds, 5 seconds, 10 seconds, Always Close or Always Open.
 - ◆ **PT Status:** Set the azimuth angle display duration while panning and tilting as 2 seconds, 5 seconds, 10 seconds, Always Close or Always Open.

- ◆ **Preset Status:** Set the preset name display duration while calling the preset as 2 seconds, 5 seconds, 10 seconds, Always Close or Always Open.
 - **Power-off Memory:** The dome can resume its previous PTZ status or actions after it restarted from a power-off. You can set the time point of which the dome resumes its PTZ status. You can set it to resume the status of 30 seconds, 60 seconds, 300 seconds or 600 seconds before power-off.
3. Click  to save the settings.

5.4.3 Configuring PTZ Limits

Purpose:

The dome can be programmed to move within the configurable PTZ limits (left/right, up/down).

Steps:

1. Enter the Limit Configuration interface:
Configuration > Advanced Configuration > PTZ > Limit

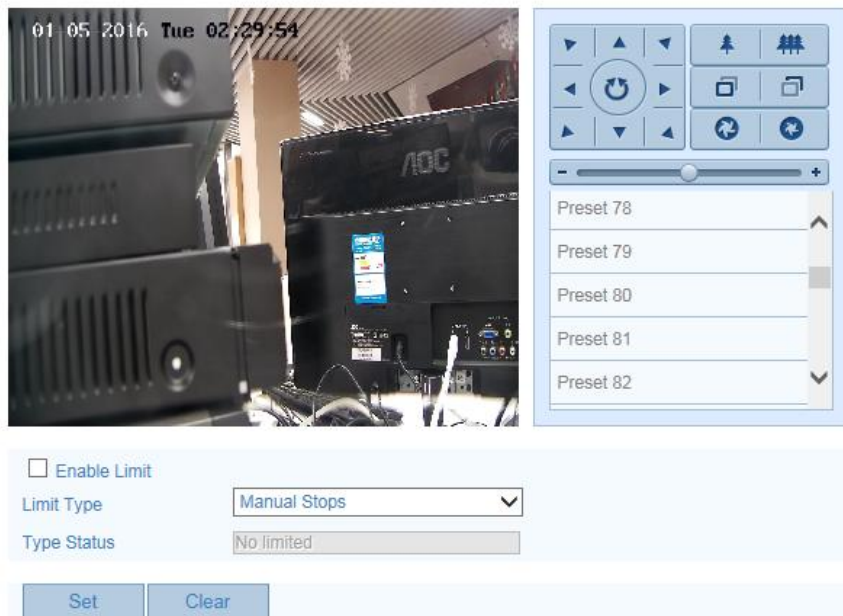

Figure 5-26 Configure the PTZ Limit

2. Click the checkbox of **Enable Limit** and choose the limit type as manual stops or scan stops.
 - **Manual Stops:**
When manual limit stops are set, you can operate the PTZ control panel manually only in the limited surveillance area.
 - **Scan Stops:**
When scan limit stops are set, the random scan, frame scan, auto scan, tilt scan, panorama scan is performed only in the limited surveillance area.



Manual Stops of **Limit Type** is prior to **Scan Stops**. When you set these two limit types at the same time, **Manual Stops** is valid and **Scan Stops** is invalid.

3. Click the PTZ control buttons to find the left/right/up/down limit stops; you can also call the defined presets and set them as the limits of the dome.
4. Click **Set** to save the limits or click **Clear** to clear the limits.

5.4.4 Configuring Scheduled Tasks

Purpose:

You can configure the network dome to perform a certain action automatically in a user-defined time period.

Steps:

1. Enter the Scheduled Task Settings interface:

Configuration > Advanced Configuration > PTZ > Scheduled Tasks

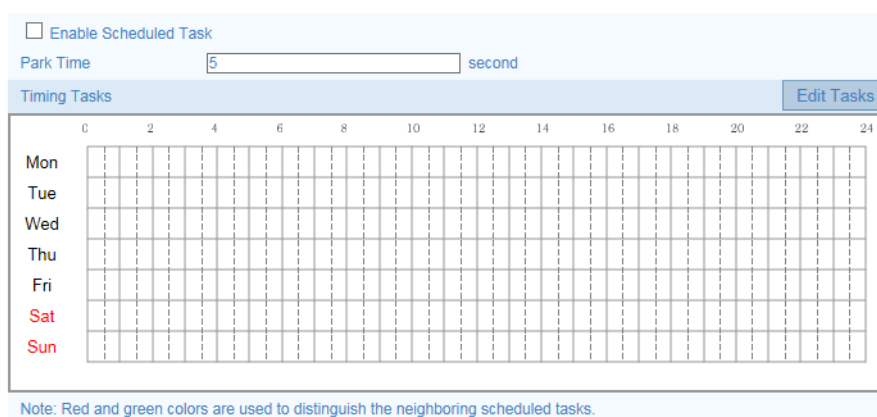

Enable Scheduled Task

Park Time second

Timing Tasks Edit Tasks

	0	2	4	6	8	10	12	14	16	18	20	22	24
Mon													
Tue													
Wed													
Thu													
Fri													
Sat													
Sun													

Note: Red and green colors are used to distinguish the neighboring scheduled tasks.

Figure 5-27 Configure Scheduled Tasks

2. Check the checkbox of **Enable Scheduled Task**.
3. Set the **Park Time**. You can set the park time (a period of inactivity) before the dome starts the scheduled tasks.
4. Set the schedule and task details.
 - (1) Click Edit Tasks to edit the task schedule.

Timing Tasks

Mon Tue Wed Thu Fri Sat Sun

All Day

Customize

Period	Start Time	End Time	Task Type	Task Type ID
1	00:00	00:00	Close	
2	00:00	00:00	Close	
3	00:00	00:00	Close	
4	00:00	00:00	Close	
5	00:00	00:00	Close	
6	00:00	00:00	Close	
7	00:00	00:00	Close	
8	00:00	00:00	Close	
9	00:00	00:00	Close	
10	00:00	00:00	Close	

Copy to Week Select All

Mon Tue Wed Thu Fri Sat Sun

Figure 5-28 Edit the Schedule and Task Type

- (2) Choose the day you want to set the task schedule.
- (3) Click **All Day** to set the schedule as all day; or click **Customize** and input the **Start Time** and **End Time** for each task, and click **Enter** on your keyboard to enter the time.
- (4) Choose the task type from the drop-down list. You can choose scan, preset, pattern, etc.
- (5) (Optional) After you set the scheduled task, you can copy the task to other days.
- (6) Click to save the settings.



The time of each task can't be overlapped. Up to 10 tasks can be configured for each day.

5. Click to save the settings.

5.4.5 Configuring Park Actions

Purpose:

This feature allows the dome to start a predefined park action (scan, preset, pattern and etc.) automatically after a period of inactivity (park time).



Scheduled Tasks function is prior to **Park Action** function. When these two functions are set at the same time, only the **Scheduled Tasks** function takes effect.

Steps:

1. Enter the Park Action Settings interface:
Configuration > Advanced Configuration > PTZ > Park Action

Figure 5-29 Set the Park Action

2. Check the checkbox of **Enable Park Action**.
3. Set the **Park Time** as the inactivity time of the dome before it starts the park actions.
4. Choose **Action Type** the from the drop-down list.

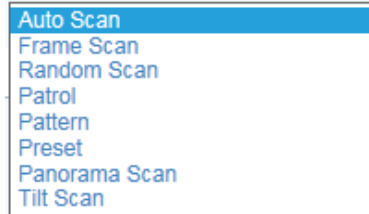

Figure 5-30 Action Types

5. Click  to save the settings.

5.4.6 Configuring Privacy Mask

Purpose:

Privacy mask enables you to cover certain areas on the live video to prevent certain spots in the surveillance area from being live viewed and recorded.

Steps:

1. Enter the Privacy Mask Settings interface:

Configuration > Advanced Configuration > PTZ > Privacy Mask

No.	Name	Type	Enable	Active Zoom Ratio
1	Privacy Mask 1	yellow	Yes	1

Figure 5-31 Draw the Privacy Mask

2. Click the PTZ control buttons to find the area you want to set the privacy mask.

3. Click **Draw Area**; click and drag the mouse in the live video window to draw the area.
4. You can drag the corners of the red rectangle area to draw a polygon mask.
5. Click **Stop Drawing** to finish drawing or click **Clear All** to clear all of the areas you set without saving them.
6. Click **Add** to save the privacy mask, and it will be listed in the **Privacy Mask List** area; you can select a mask and click **Delete** to delete it from the list; you can also define the color of the masks.

No.	Name	Type	Enable	Active Zoom Ratio
1	Privacy Mask 1	yellow	Yes	1

Figure 5-32 Privacy Mask List

7. Check the checkbox of **Enable Privacy Mask** to enable this function.



You are allowed to draw up to 8 areas for the speed dome.

5.4.7 Clearing PTZ Configurations

Purpose:

You can clear PTZ configurations in this interface, including all presets, patrols, patterns, privacy masks, PTZ limits, scheduled tasks and park actions.

Steps:

1. Enter the Clearing Configuration interface:
Configuration > Advanced Configuration > PTZ > Clear Config
2. Check the checkbox of the items you want to clear.
3. Click **Save** to clear the settings.

5.4.8 Configuring Smart Tracking



The functions vary depending on the models of speed dome.

Purpose:

The speed dome tracks the moving objects automatically after you configure this function.

Steps:

1. Enter the Smart Tracking Settings interface:
Configuration > PTZ > Smart Tracking

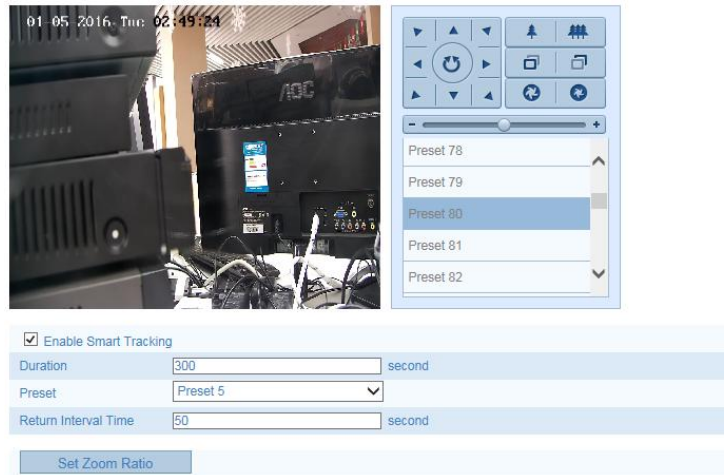

Figure 5-33 Configure Smart Tracking

2. Check the **Enable Smart Tracking** check box to enable smart tracking function.
3. Click the PTZ buttons to select an object.
4. Click to set the current zoom ratio as the tracking zoom ratio.
5. Set the tracking duration. The speed dome stops tracking when the duration time is up. The duration ranges from 0 to 300 seconds.



- Setting the duration to 0 means that there' no duration when speed dome tracks.
- Not all the speed dome models support this function. Please take the browser interface of the actual product as standard.

5.4.9 Configuring PTZ Control Priority



The functions vary depending on the models of speed dome.

Steps:

1. Get to the configuration interface:
Configuration > PTZ > Prioritize PTZ.
 - The speed dome can be controlled by network and RS-485 signals. You can set the control priority of these two signals.
 - The operation of **Operator** is prior to that of **User**. When the **Operator** is controlling the speed dome, the **User** cannot control it. When the **Operator** finishes, the **User** can control the speed dome after the **Delay** time. The **Delay** time can be set in Priority PTZ interface as shown follows.

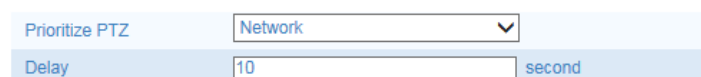

Figure 5-34 PTZ Priority

Click to activate the settings.

Chapter 6 Speed Dome Configuration

6.1 Configuring Local Parameters



The local configuration refers to the parameters of the live view and other operations using the web browser.

Steps:

- Enter the Local Configuration interface:
Configuration > Local Configuration

Live View Parameters	
Protocol	<input checked="" type="radio"/> TCP <input type="radio"/> UDP <input type="radio"/> MULTICAST <input type="radio"/> HTTP
Live View Performance	<input type="radio"/> Shortest Delay <input checked="" type="radio"/> Auto
Rules	<input type="radio"/> Enable <input checked="" type="radio"/> Disable
Image Format	<input checked="" type="radio"/> JPEG <input type="radio"/> BMP

Record File Settings	
Record File Size	<input type="radio"/> 256M <input checked="" type="radio"/> 512M <input type="radio"/> 1G
Save record files to	<input type="text" value="C:\Users\sharon.xie\Web\RecordFiles"/> <input type="button" value="Browse"/>
Save downloaded files to	<input type="text" value="C:\Users\sharon.xie\Web\DownloadFiles"/> <input type="button" value="Browse"/>

Picture and Clip Settings	
Save snapshots in live view to	<input type="text" value="D:\"/> <input type="button" value="Browse"/>
Save snapshots when playback to	<input type="text" value="C:\Users\sharon.xie\Web\PlaybackPics"/> <input type="button" value="Browse"/>
Save clips to	<input type="text" value="C:\Users\sharon.xie\Web\PlaybackFiles"/> <input type="button" value="Browse"/>

Figure 6-1 Local Configuration Interface

- Configure the following settings:
 - Live View Parameters:** Set the protocol type, stream type, image size and live view performance.
 - Protocol Type:** TCP, UDP, MULTICAST and HTTP are selectable.
 - TCP:** Ensures complete delivery of streaming data and better video quality, yet the real-time transmission will be affected.
 - UDP:** Provides real-time audio and video streams.
 - HTTP:** Allows the same quality as of TCP without setting specific ports for streaming under some network environments.
 - MULTICAST:** It's recommended to select the protocol type to MULTICAST when using the Multicast function. For other information about Multicast, refer to Section **6.3.1 Configuring TCP/IP Settings**.
 - Live View Performance:** Set the live view performance to Shortest Delay, or Auto.
 - Rules:** You can enable or disable the rules of dynamic analysis for motion here.
 - Image Format:** The captured pictures can be saved as different format. JPEG and BMP are available.
 - Record File Settings:** Set the saving path of the video files.
 - Record File Size:** Select the packed size of manually recorded and downloaded video files. The size can be set to 256M, 512M or 1G.

- ◆ **Save record files to:** Set the saving path for the manually recorded video files.
- ◆ **Save downloaded files to:** Set the saving path for the downloaded video files in **Playback** interface.
- **Picture and Clip Settings:** Set the saving paths of the captured pictures and clipped video files.
 - ◆ **Save snapshots in live view to:** Set the saving path of the manually captured pictures in **Live View** interface.
 - ◆ **Save snapshots when playback to:** Set the saving path of the captured pictures in **Playback** interface.
 - ◆ **Save clips to:** Set the saving path of the clipped video files in **Playback** interface.



You can click **Browse** to change the directory for saving video files, clips and pictures.

6. Click **Save** to save the settings.

6.2 Configuring Time Settings

Purpose:

You can follow the instructions in this section to configure the time which can be displayed on the video. There are Time Zone, Time Synchronization, Daylight Saving Time (DST) functions for setting the time. Time Synchronization consists of auto mode by Network Time Protocol (NTP) server and manual mode.

To enter the Time Settings interface:

Configuration > Basic Configuration > System > Time Settings

Or **Configuration > Advanced Configuration > System > Time Settings**

Figure 6-2 Time Settings

- **Configuring Time Synchronization by NTP Server**

Steps:

- (1) Check the radio button to enable the **NTP** function.
- (2) Configure the following settings:

Server Address: IP address of NTP server.

NTP Port: Port of NTP server.

Interval: The time interval between the two synchronizing actions by NTP server. It can be set from 1 to 10080 minutes.

Figure 6-3 Time Sync by NTP Server

You can click **Test** to make sure that the NTP server is connected.



If the speed dome is connected to a public network, you should use a NTP server that has a time synchronization function, such as the server at the National Time Center (IP Address: 210.72.145.44). If the speed dome is set in a customized network, NTP software can be used to establish a NTP server for time synchronization.

● Configuring Time Synchronization Manually

Steps:

- (1) Check the **Manual Time Sync** radio button.
- (2) Click to set the system time from the pop-up calendar.
- (3) Click to save the settings.



You can also check the **Sync with local time** checkbox to synchronize the time of the speed dome with the time of your computer.

Figure 6-4 Time Sync Manually

● Select the Time Zone

Purpose:

When the speed dome is taken to another time zone, you can use the **Time Zone** function to adjust the time. The time will be adjusted according to the original time and the time difference between the two time zones.

From the **Time Zone** drop-down menu as shown in Figure 6-5, select the Time Zone in which the speed dome locates.

Figure 6-5 Time Zone Settings

● Configuring Daylight Saving Time (summer time)

Purpose:

If there is the habit of adjusting clocks forward in your country in certain time period of a

year, you can turn this function on. The time will be adjusted automatically when the Daylight Saving Time(DST) comes.

Steps:

- (1) Enter the **DST** interface by **Configuration > Advanced Configuration > System > DST**
- (2) Check Enable DST to enable the DST function.
- (3) Set the date of the DST period.
- (4) Click to save the settings.

DST					
<input checked="" type="checkbox"/>	Enable DST				
Start Time	Apr	First	Sun	02	o'clock
End Time	Oct	Last	Sun	02	o'clock
DST Bias	30min				

Figure 6-6 DST Settings

6.3 Configuring Network Settings

6.3.1 Configuring TCP/IP Settings

Purpose:

TCP/IP settings must be properly configured before you operate the speed dome over network. IPv4 and IPv6 are both supported.

Steps:

1. Enter TCP/IP Settings interface:

Configuration > Basic Configuration > Network > TCP/IP

Or **Configuration > Advanced Configuration > Network > TCP/IP**

TCP/IP	
NIC Settings	
NIC Type	Auto
<input type="checkbox"/> DHCP	
IPv4 Address	192.168.1.68
IPv4 Subnet Mask	255.255.255.0
IPv4 Default Gateway	192.168.1.1
IPv6 Mode	Route Advertisement <input type="button" value="View Route.."/>
IPv6 Address	:
IPv6 Subnet Mask	0
IPv6 Default Gateway	
Mac Address	8ce748e7c8ae
MTU	1500
Multicast Address	
DNS Server	
Preferred DNS Server	8.8.8.8
Alternate DNS Server	
<input type="button" value="Save"/>	

Figure 6-7 TCP/IP Settings

- Configure the NIC settings, including the **IPv4(IPv6) Address, IPv4(IPv6) Subnet Mask** and **IPv4(IPv6) Default Gateway**.
- Click to save the above settings.

You can click **Test** to make sure that the IP address is valid.



- If the DHCP server is available, you can check DHCP to automatically obtain an IP address and other network settings from that server.
- The valid value range of Maximum Transmission Unit (MTU) is 500 ~ 1500. The default value is 1500.
- The Multicast sends a stream to the multicast group address and allows multiple clients to acquire the stream at the same time by requesting a copy from the multicast group address. Before utilizing this function, you have to enable the Multicast function of your router and configure the gateway of the network speed dome.
- If the DNS server settings are required for some applications (e.g., sending email), you should properly configure the **Preferred DNS Server** and **Alternate DNS server**.

Figure 6-8 DNS Server Settings



The router must support the route advertisement function if you select **Route Advertisement** as the IPv6 mode.

6.3.2 Configuring Port Settings

Purpose:

If there is a router and you want to access the speed dome through Wide Area Network (WAN), you need to forward the 3 ports for the speed dome.

Steps:

- Enter the Port Settings interface:
Configuration > Basic Configuration > Network > Port
Or Configuration > Advanced Configuration > Network > Port

Figure 6-9 Port Settings

- Set the HTTP port, RTSP port and port of the speed dome.
HTTP Port: The default port number is 80.

RTSP Port: The default port number is 554.

HTTPS Port: The default port number is 443.

Server Port: The default port number is 8000.

- Click  to save the settings.

6.3.3 Configuring PPPoE Settings

Purpose:

If you have no router but only a modem, you can use Point-to-Point Protocol over Ethernet (PPPoE) function.

Steps:

- Enter the PPPoE Settings interface:

Configuration > Advanced Configuration > Network > PPPoE



Figure 6-10 PPPoE Settings

- Check the **Enable PPPoE** checkbox to enable this feature.
- Enter **User Name**, **Password**, and **Confirm** password for PPPoE access.



The User Name and Password should be assigned by your ISP.



- *For your privacy and to better protect your system against security risks, we strongly recommend the use of strong passwords for all functions and network devices. The password should be something of your own choosing (using a minimum of 8 characters, including upper case letters, lower case letters, numbers and special characters) in order to increase the security of your product.*
- *Proper configuration of all passwords and other security settings is the responsibility of the installer and/or end-user.*

- Click  to save and exit the interface.

6.3.4 Configuring DDNS Settings

Purpose:

If your speed dome is set to use PPPoE as its default network connection, you can use the Dynamic DNS (DDNS) for network access.

Before you start:

Registration on the DDNS server is required before configuring the DDNS settings of the speed

dome.



- For your privacy and to better protect your system against security risks, we strongly recommend the use of strong passwords for all functions and network devices. The password should be something of your own choosing (using a minimum of 8 characters, including upper case letters, lower case letters, numbers and special characters) in order to increase the security of your product.
- Proper configuration of all passwords and other security settings is the responsibility of the installer and/or end-user.

Steps:

1. Enter the DDNS Settings interface:

Configuration > Advanced Configuration > Network > DDNS

<input checked="" type="checkbox"/> Enable DDNS	
DDNS Type	LTS
Server Address	ns1.dvrlists.com
Domain	ltn5204-p4.dvrlists.com
Port	0
User Name	wenfeihexy@126.com
Password	•••••
Confirm	•••••

Figure 6-11 DDNS Settings

2. Check the **Enable DDNS** checkbox to enable this feature.
3. Select **DDNS Type**. Three DDNS types are selectable: IP Server, HiDDNS, NO-IP and DynDNS.

- **DynDNS:**

Steps:

- (1) Enter **Server Address** of DynDNS (e.g. members.dyndns.org).
- (2) In the **Domain** text field, enter the domain name obtained from the DynDNS website.
- (3) Enter the **Port** of DynDNS server.
- (4) Enter the **User Name** and **Password** registered on the DynDNS website.
- (5) Click to save the settings.

<input checked="" type="checkbox"/> Enable DDNS	
DDNS Type	DynDNS
Server Address	
Domain	
Port	0
User Name	
Password	
Confirm	

Figure 6-12 DynDNS Settings

- **IP Server:**

Steps:

- (1) Enter the Server Address of the IP Server.

(2) Click to save the settings.



The **Server Address** should be entered with the static IP address of the computer that runs the IP Server software. For the IP Server, you have to apply a static IP, subnet mask, gateway and preferred DNS from the ISP.

<input checked="" type="checkbox"/> Enable DDNS	
DDNS Type	IPServer
Server Address	<input type="text"/>
Domain	<input type="text"/>
Port	0
User Name	<input type="text"/>
Password	<input type="text"/>
Confirm	<input type="text"/>

Figure 6-13 IPServer Settings

- **HiDDNS:**

Steps:

- (1) Enter the Server Address: www.hiddns.com.
- (2) Enter the Domain name of the camera. The domain is the same with the device alias in the HiDDNS server.
- (3) Click to save the settings.

<input checked="" type="checkbox"/> Enable DDNS	
DDNS Type	HiDDNS
Server Address	<input type="text"/>
Domain	<input type="text"/>
Port	0
User Name	<input type="text"/>
Password	<input type="text"/>
Confirm	<input type="text"/>

Figure 6-14 HiDDNS Settings

- **NO-IP:**

Steps:

- (1) Enter **Server Address** of NO-IP.
- (2) In the **Domain** text field, enter the domain name obtained from the NO-IP website.
- (3) Enter the **Port** of NO-IP server.
- (4) Enter the **User Name** and **Password** registered on the NO-IP website.
- (5) Click to save the settings.

- **LTS:**

Steps:

- (1) Enter the Server Address: ns1.dvrlists.com.
- (2) Enter the Domain name of the camera. The domain is the same with the device alias in the LTS DDNS server.
- (3) Click to save the settings.

TCP/IP	Port	DDNS	PPPoE	SNMP	802.1X	QoS	FTP	NAT	Email
<input checked="" type="checkbox"/> Enable DDNS									
DDNS Type		LTS							
Server Address		ns1.dvrlists.com/							
Domain									
Port		0							
User Name									
Password									
Confirm									
<input type="button" value="Save"/>									

Figure 6-15 LTS DDNS Settings

6.3.5 Configuring SNMP Settings

Purpose:

You can use SNMP to get speed dome status and parameters related information.

Before you start:

Before setting the SNMP, please use the SNMP software and manage to receive the speed dome information via SNMP port. By setting the Trap Address, the speed dome can send the alarm event and exception messages to the surveillance center.



The SNMP version you select should be the same as that of the SNMP software.

Steps:

1. Enter the SNMP Settings interface:

Configuration > Advanced Configuration > Network > SNMP

SNMP v1/v2	
Enable SNMPv1	<input type="checkbox"/>
Enable SNMP v2c	<input type="checkbox"/>
Write SNMP Community	private
Read SNMP Community	public
Trap Address	
Trap Port	162
Trap Community	public

SNMP v3	
Enable SNMPv3	<input type="checkbox"/>
Read UserName	
Security Level	no auth, no priv
Authentication Algorithm	<input checked="" type="radio"/> MD5 <input type="radio"/> SHA
Authentication Password	
Private-key Algorithm	<input checked="" type="radio"/> DES <input type="radio"/> AES
Private-key password	
Write UserName	
Security Level	no auth, no priv
Authentication Algorithm	<input checked="" type="radio"/> MD5 <input type="radio"/> SHA
Authentication Password	
Private-key Algorithm	<input checked="" type="radio"/> DES <input type="radio"/> AES
Private-key password	

SNMP Other Settings	
SNMP Port	161

Figure 6-16 SNMP Settings

2. Check the corresponding version checkbox ([Enable SNMPv1](#) , [Enable SNMP v2c](#) , [Enable SNMPv3](#)) to enable the feature.
3. Configure the SNMP settings.



The configuration of the SNMP software should be the same as the settings you configure here.

4. Click [Save](#) to save and finish the settings.

6.3.6 Configuring 802.1X Settings

Purpose:

The speed dome supports IEEE 802.1X standard.

IEEE 802.1X is a port-based network access control. It enhances the security level of the LAN. When devices connect to this network with IEEE 802.1X standard, the authentication is needed. If the authentication fails, the devices don't connect to the network.

The protected LAN with 802.1X standard is shown as follows:

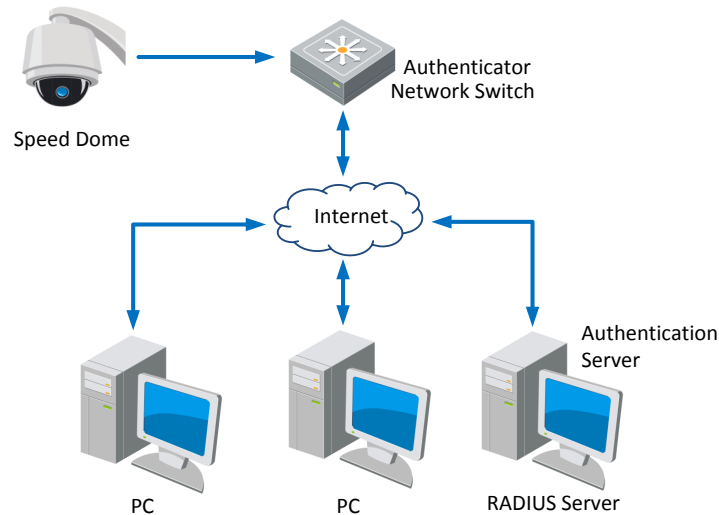

Figure 6-17 Protected LAN

- Before connecting the Network Camera to the protected LAN, please apply a digital certificate from a Certificate Authority.
- The network camera requests access to the protected LAN via the authenticator (a switch).
- The switch forwards the identity and password to the authentication server (RADIUS server).
- The switch forwards the certificate of authentication server to the network camera.
- If all the information is validated, the switch allows the network access to the protected network.



- *For your privacy and to better protect your system against security risks, we strongly recommend the use of strong passwords for all functions and network devices. The password should be something of your own choosing (using a minimum of 8 characters, including upper case letters, lower case letters, numbers and special characters) in order to increase the security of your product.*
- *Proper configuration of all passwords and other security settings is the responsibility of the installer and/or end-user.*

Steps:

1. Connect the network camera to your PC directly with a network cable.
2. Enter the 802.1X Settings interface:

Configuration > Advanced Configuration > Network > 802.1X

<input type="checkbox"/> Enable IEEE 802.1X	
Protocol	EAP-MD5
EAPOL version	1
User Name	
Password	
Confirm	

Figure 6-18 802.1X Settings

3. Check the **Enable IEEE 802.1X** checkbox to enable it.
4. Configure the 802.1X settings, including user name and password.



The EAP-MD5 version must be identical with that of the router or the switch.

5. Click to finish the settings.



The camera reboots when you save the settings.

6. After the configuration, connect the camera to the protected network.

6.3.7 Configuring QoS Settings

Purpose:

QoS (Quality of Service) can help solve the network delay and network congestion by configuring the priority of data sending.

Steps:

1. Enter the QoS Settings interface:

Configuration > Advanced Configuration > Network > QoS

Video/Audio DSCP	<input type="text" value="0"/>
Event/Alarm DSCP	<input type="text" value="0"/>
Management DSCP	<input type="text" value="0"/>

Figure 6-19 QoS Settings

2. Configure the QoS settings, including video / audio DSCP, event / alarm DSCP and Management DSCP.

The valid DSCP value ranges from 0 to 63. The DSCP value is bigger, the priority is higher.

3. Click to save the settings.



- Make sure that you enable the QoS function of your network device (such as a router).
- It will ask for a reboot for the settings to take effect.

6.3.8 Configuring FTP Settings

Purpose:

You can set a FTP server and configure the following parameters for uploading captured pictures.

Steps:

1. Enter the FTP Settings interface:

Configuration > Advanced Configuration > Network > FTP

Server Address	<input type="text" value="0.0.0.0"/>
Port	<input type="text" value="21"/>
User Name	<input type="text"/> <input type="checkbox"/> Anonymous
Password	<input type="password"/>
Confirm	<input type="password"/>
Directory Structure	<input type="text" value="Save in the root directory."/> ▼
Parent Directory	<input type="text" value="Use Device Name"/> ▼
Child Directory	<input type="text" value="Use Camera Name"/> ▼
Upload Type	<input type="checkbox"/> Upload Picture
<input type="button" value="Test"/>	

Figure 6-20 FTP Settings

- Configure the FTP settings, including server address, port, user name, password, directory and upload type.



The server address supports both the domain name and IP address formats.



- For your privacy and to better protect your system against security risks, we strongly recommend the use of strong passwords for all functions and network devices. The password should be something of your own choosing (using a minimum of 8 characters, including upper case letters, lower case letters, numbers and special characters) in order to increase the security of your product.
- Proper configuration of all passwords and other security settings is the responsibility of the installer and/or end-user.
- Setting the directory in FTP server for saving files:**
In the **Directory Structure** field, you can select the root directory, parent directory and child directory.
 - Root directory:** The files will be saved in the root of FTP server.
 - Parent directory:** The files will be saved in a folder in FTP server. The name of folder can be defined as shown in following Figure 6-21.

Use Device Name	▼
Use Device Name	
Use Device Number	
Use Device IP address	
Custom	

Figure 6-21 Parent Directory

- Child directory:** It is a sub-folder which can be created in the parent directory. The files will be saved in a sub-folder in FTP server. The name of folder can be defined as shown in following Figure 6-22.

Use Camera Name	▼
Use Camera Name	
Use Camera Number	
Custom	

Figure 6-22 Child Directory

- **Upload type:** To enable uploading the captured picture to the FTP server.
3. Click  to save the settings.
 4. You can click **Test** to confirm the configuration.



If you want to upload the captured pictures to FTP server, you also have to enable the continuous snapshot or event-triggered snapshot in **Snapshot** interface. For detailed information, please refer to the Section **7.3 Configuring Snapshot Settings**.

6.3.9 Configuring UPnP™ Settings

Universal Plug and Play (UPnP™) is a networking architecture that provides compatibility among networking equipment, software and other hardware devices. The UPnP protocol allows devices to connect seamlessly and to simplify the implementation of networks in the house and corporate environments.

With the function enabled, you don't need to configure the port mapping for each port, and the camera is connected to the Wide Area Network via the router.

Steps:

1. Enter the UPnP™ settings interface.

Configuration > Advanced Configuration > Network > UPnP

2. Check the checkbox to enable the UPnP™ function.

You can edit the Friendly Name of the speed dome. This name can be detected by corresponding device, such as a router.

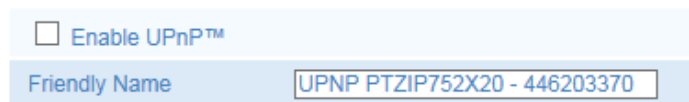

The screenshot shows a configuration interface for UPnP. It features a checkbox labeled "Enable UPnP™" which is currently unchecked. Below this is a text input field labeled "Friendly Name" containing the text "UPNP PTZIP752X20 - 446203370".

Figure 6-23 Configure UPnP Settings

6.3.10 Configuring NAT (Network Address Translation) Settings

Steps:

1. Set the port mapping mode:

To port mapping with the default port numbers:

Choose  Auto

To port mapping with the customized port numbers:

Choose  Manual

And you can customize the value of the port number by yourself.

<input checked="" type="checkbox"/> Enable Port Mapping				
Port Mapping Mode: Manual				
	Port Type	External Port	External IP Address	Status
<input checked="" type="checkbox"/>	HTTP	80	0.0.0.0	Not Valid
<input checked="" type="checkbox"/>	RTSP	2011	0.0.0.0	Not Valid
<input checked="" type="checkbox"/>	Server Port	2012	0.0.0.0	Not Valid

- Click Save to save the settings.

6.3.11 Configuring Email Settings

Purpose:

The system can be configured to send an Email notification to all designated receivers if an alarm event is detected, e.g., motion detection event, video loss, tamper-proof, etc.

Before you start:

Please configure the DNS Server settings under **Basic Configuration > Network > TCP/IP** or **Advanced Configuration > Network > TCP/IP** before using the Email function.

Steps:

- Enter the Email Settings interface:

Configuration > Advanced Configuration > Network > Email

Sender	
Sender	<input type="text" value="123"/>
Sender's Address	<input type="text" value="wenfeihecxy@126.com"/>
SMTP Server	<input type="text" value="smtp.126.com"/>
SMTP Port	<input type="text" value="25"/>
<input type="checkbox"/> Enable SSL	
Interval	<input type="text" value="2s"/> <input checked="" type="checkbox"/> Attached Image
<input checked="" type="checkbox"/> Authentication	
User Name	<input type="text" value="wenfeihecxy@126.com"/>
Password	<input type="password" value="•••••"/>
Confirm	<input type="password" value="•••••"/>
Receiver	
Receiver1	<input type="text" value="12"/>
Receiver1's Address	<input type="text" value="frank.chen@brovisiontech.com"/> Test
Receiver2	<input type="text"/>
Receiver2's Address	<input type="text"/>
Receiver3	<input type="text"/>
Receiver3's Address	<input type="text"/>

Figure 6-24 Email Settings

- Configure the following settings:

Sender: The name of the email sender.

Sender's Address: The email address of the sender.

SMTP Server: The SMTP Server IP address or host name (e.g., smtp.263xmail.com).

SMTP Port: The SMTP port. The default TCP/IP port for SMTP is 25.

Enable SSL: Check the checkbox to enable SSL if it is required by the SMTP server.

Attached Image: Check the checkbox of Attached Image if you want to send emails with attached alarm images.

Interval: The interval refers to the time between two actions of sending attached pictures.

Authentication (optional): If your email server requires authentication, check this checkbox to use authentication to log in to this server and enter the login user name and password.



- *For your privacy and to better protect your system against security risks, we strongly recommend the use of strong passwords for all functions and network devices. The password should be something of your own choosing (using a minimum of 8 characters, including upper case letters, lower case letters, numbers and special characters) in order to increase the security of your product.*
- *Proper configuration of all passwords and other security settings is the responsibility of the installer and/or end-user.*

Receiver: Select the receiver to which the email is sent. Up to 2 receivers can be configured.

Receiver: The name of the user to be notified.

Receiver's Address: The email address of user to be notified. (Optional: click Test to make sure that the email server can send email out.)

3. Click  to save the settings.

6.3.12 Configuring Platform Access Settings

● Configuring Cloud P2P

Purpose:

Cloud P2P provides the mobile phone application and as well the service platform page to access and manage your connected NVR, which enables you to get a convenient remote access to the surveillance system.

Steps:

1. Enter the Platform Access configuration interface.
Configuration > Advanced Configuration > Network > Platform Access
2. Check the checkbox of the Enable.
3. Select the Platform Type as the **Cloud P2P** in the dropdown list.
4. Click the Save button to activate the settings.

You can view the register status of the device in the corresponding text.



Among the Cloud P2P and DDNS, you can only select one of them to enable.

6.3.13 Configuring HTTPS Settings

Purpose:

HTTPS is consisted by SSL&HTTP. It is used for encryption transmission, identity authentication network protocol which enhances the security of WEB accessing.



- For your privacy and to better protect your system against security risks, we strongly recommend the use of strong passwords for all functions and network devices. The password should be something of your own choosing (using a minimum of 8 characters, including upper case letters, lower case letters, numbers and special characters) in order to increase the security of your product.
- Proper configuration of all passwords and other security settings is the responsibility of the installer and/or end-user.
- **To Create Self-signed Certificate:**

Steps:

Enable HTTPS

Create

Create Self-signed Certificate

Create Certificate Request

Install Signed Certificate

Certificate Path Browse Upload

Created Request

Created Request Delete Download

Installed Certificate

Installed Certificate Delete

Property

Subject: C=CN, ST=ZJ, L=HZ, OU=embeddedsoftware, H/IP=192.168.1.150, EM=com.cn
 Issuer: C=CN, ST=ZJ, L=HZ, OU=embeddedsoftware, H/IP=192.168.1.150, EM=com.cn
 Validity: 2014-08-15 06:46:08 ~ 2017-08-14 06:46:08

Figure 6-25 HTTPS Settings

1. Click **Create** on the left of **Create Self-signed Certificate**.
2. In the pop-up interface, input the Country, Hostname/IP, Validity, Password, etc.. Click **OK**.
The Self-signed Certificate information is displayed under **Installed Certificate**. If you need to disable this certificate, click **Delete** on the right of **Installed Certificate**.
3. Check the checkbox of Enable HTTPS and click the **Save** button.

- **To Install Authoritative Certificate:**

For more secure HTTPS access, you can purchase an authoritative certificate from a CA (Certificate Authority). Install this certificate to the device.

Steps:

1. Click **Create** on the left of **Create Certificate Request**.
2. In the pop-up interface, input the Country, Hostname/IP, Validity, Password, etc.. Click **OK**.
3. Check the checkbox of Enable HTTPS and click the **Save** button.

- **To access the speed dome via HTTPS:**

Steps:

1. Open the web browser.
2. Input the IP address of the network speed dome and press the **Enter** key to enter the login interface.



- The default port number of HTTPS is 443. The port value ranges from 1 to 65535.
- When the port number is the default number 443, the format of the URL is **https://IP address**, eg., https://192.168.1.64.
- When the port number is not the default number 443, the format of the URL is **https://IP address:port number**, eg., https://192.168.1.64:81.

6.4 Configuring Video and Audio Settings

6.4.1 Configuring Video Settings

Steps:

1. Enter the Video Settings interface:

Configuration > Basic Configuration > Video / Audio > Video

Or **Configuration > Advanced Configuration > Video / Audio > Video**

Stream Type	Main Stream(Normal)	▼
Video Type	Video Stream	▼
Resolution	1920*1080P	▼
Bitrate Type	Variable	▼
Video Quality	Medium	▼
Frame Rate	30	▼ fps
Max. Bitrate	4096	Kbps
Video Encoding	H.264	▼
Profile	High Profile	▼
I Frame Interval	50	
SVC	OFF	▼
Smoothing	<input type="range" value="50"/> 50	

Figure 6-26 Configure Video Settings

2. Select the **Stream Type** of the speed dome to main stream (normal) or sub-stream.
The main stream is usually for recording and live viewing with good bandwidth, and the sub-stream can be used for live viewing when the bandwidth is limited. Refer to the Section **6.1 Configuring Local Parameters** for switching the main stream and sub-stream for live viewing.
3. You can customize the following parameters for the selected main stream or sub-stream:

Video Type:

Select the stream type to video stream, or video & audio composite stream. The audio signal will be recorded only when the **Video Type** is **Video & Audio**.

Resolution:

Select the resolution of the video output.

Bitrate Type:

Select the bitrate type to constant or variable.

Video Quality:

When bitrate type is selected as **Variable**, 6 levels of video quality are selectable.

Frame Rate:

The frame rate is to describe the frequency at which the video stream is updated and it is measured by frames per second (fps). A higher frame rate is advantageous when there is movement in the video stream, as it maintains image quality throughout.

Max. Bitrate:

Set the max. bitrate to 32~12288Kbps. The higher value corresponds to the higher video quality, but the higher bandwidth is required.

Video Encoding:

The **Video Encoding** standard can be set to H.264.

I Frame Interval:

Set the I-Frame interval from 2 to 250.

SVC:

SVC(Scalable video coding technology) is for storing videos when the bandwidth is limited. To use this function, a specified H.264 encoding storage device is necessary.

4. Click  to save the settings.

6.4.2 Configuring Audio Settings

Steps:

1. Enter the Audio Settings interface

Configuration > Basic Configuration > Video / Audio > Audio

Or **Configuration > Advanced Configuration > Video / Audio > Audio**

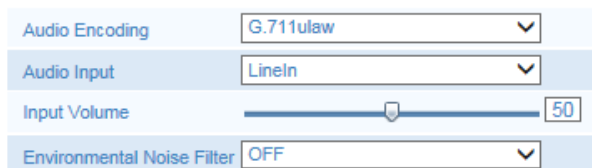

Audio Encoding	G.711ulaw
Audio Input	LineIn
Input Volume	50
Environmental Noise Filter	OFF

Figure 6-27 Audio Settings

2. Configure the following settings.

Audio Encoding: G.722.1, G.711ulaw, G.711alaw, MP2L2 and G.726 selectable.

Audio Input: When an intercom is connected to the speed dome, you need to set this option to **LineIn**. When a microphone is connected to the speed dome, you need to set this option to **MicIn**.

Audio Stream Bitrate: When the Audio Encoding is selected as MP2L2, you can configure the Audio Stream Bitrate in the dropdown list. The greater the value is, the better the audio quality will be.

Sampling Rate: When the Audio Encoding is selected as MP2L2, you can configure the

Sampling Rate in the dropdown list. The greater the value is, the better the audio quality will be.

Input Volume: Slid the **bar** to turn up/down the volume. The value ranges from 0 to 100.

Environmental Noise Filter: Select ON or OFF in the dropdown list to enable or disable the function. It's recommended to enable the function when the sampling rate is lower than 32kHz.

3. Click  to save the settings.

6.4.3 Configuring ROI Settings

Before you start:

ROI (Region of Interest) encoding is used to enhance the quality of images which are specified in advance.

Stream Type:

You can set the ROI function for main stream or sub stream. Select a stream type and then configure the ROI settings.

- **Fixed Region:** The fixed region encoding is the ROI encoding for the manually configured area. And you can choose the Image Quality Enhancing level for ROI encoding, and you can also name the ROI area.

Steps:

1. Select a **Region No.**
2. Check the checkbox of **Enable** under **Fixed Region**.
3. Click  and draw a red frame in the live view image.
4. Adjust the **ROI level** from 1 to 6. The higher the value, the better image quality in the red frame.
5. Enter a **Region Name** and click **Save** to save the settings.

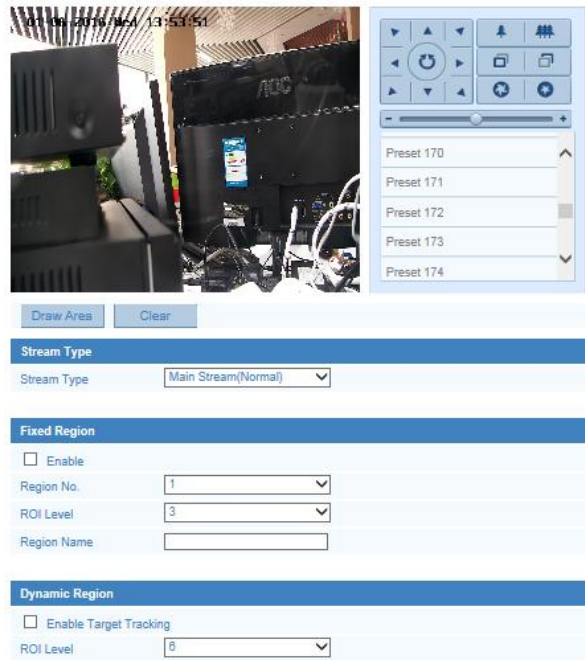



Figure 6-28 Region of Interest

6.4.4 Configuring Dual-VCA

Purpose:

Enable the VCA function and then the information of the objects (e.g. human, vehicle, etc.) will be marked in the video stream and you can set rules on the connected back-end device to detect the events including line crossing, intrusion, etc..

Steps:

1. Enter the Dual-VCA function configuration interface.
Configuration> Advanced Configuration> Video/Audio> Display Info. on Stream
2. Check the **Enable Dual-VCA** checkbox.
3. Click  to save the settings.

6.5 Configuring Image Settings

6.5.1 Configuring Display Settings

Purpose:

You can set the image quality of the speed dome, including brightness, contrast, saturation, sharpness, etc.



- The parameters in **Display Settings** interface vary depending on the models of speed dome.
- You can double click the live view to enter full screen mode and double click it again to exit.

Steps:

1. Enter the Display Settings interface:
Configuration > Basic Configuration> Image> Display Settings
Or Configuration > Advanced Configuration> Image> Display Settings
2. You can select the **Mounting Scenario** in the dropdown list with different predefined image parameters.
3. Set the image parameters of the speed dome.

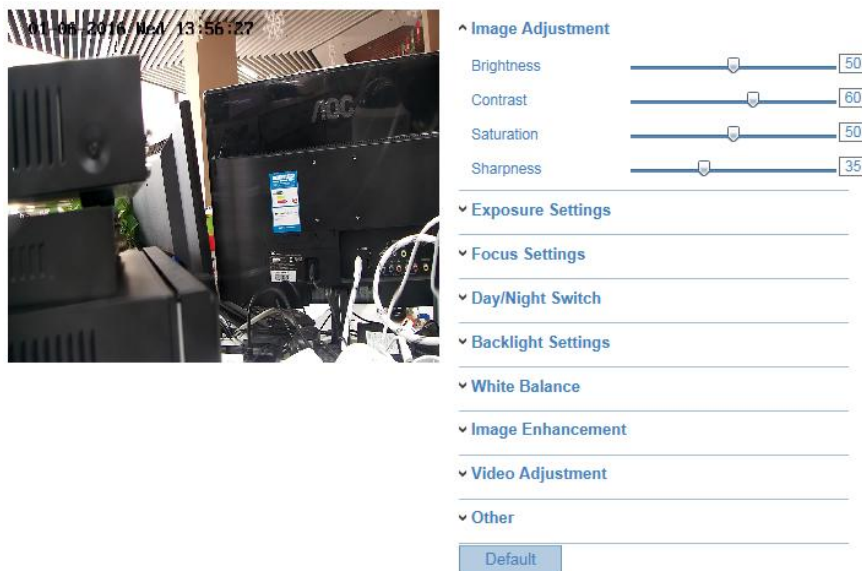

Figure 6-29 Display Settings

Image Adjustment

- **Brightness**

This feature is used to adjust brightness of the image. The value ranges from 0 to 100.

- **Contrast**

This feature enhances the difference in color and light between parts of an image. The value ranges from 0 to 100.

- **Saturation**

This feature is used to adjust color saturation of the image. The value ranges from 0 to 100.

- **Sharpness**

Sharpness function enhances the detail of the image by sharpening the edges in the image. The value ranges from 0 to 100.



This function varies depending on the models of speed dome.

Exposure Settings

● Exposure Mode

The **Exposure Mode** can be set to **Auto**, **Iris Priority**, **Shutter Priority**, **Manual**.

◆ Auto:

The iris, shutter and gain values will be adjusted automatically according to the brightness of the environment. You can set the iris range and shutter ranges by setting the Max. Iris Limit, Min. Iris Limit, Max. Shutter Limit, and Min. Shutter Limit respectively.

◆ Iris Priority:

The value of iris needs to be adjusted manually. The shutter and gain values will be adjusted automatically according to the brightness of the environment.

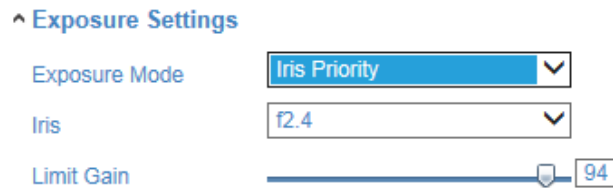

Figure 6-30 Manual Iris

◆ Shutter Priority:

The value of shutter needs to be adjusted manually. The iris and gain values will be adjusted automatically according to the brightness of the environment.

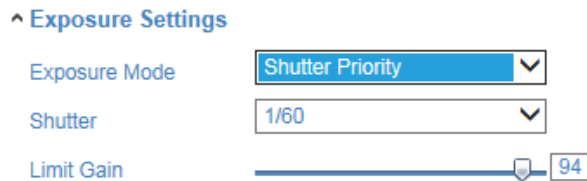

Figure 6-31 Manual Shutter

◆ Gain Priority:

The value of gain needs to be adjusted manually. The shutter and iris values will be adjusted automatically according to the brightness of the environment.



Figure 6-32 Manual Gain

◆ Manual:

In **Manual** mode, you can adjust the values of **Gain**, **Shutter**, **Iris** manually.



This function varies depending on the models of speed dome.

● Limit Gain

This feature is used to adjust gain of the image. The value ranges from 0 to 100.

Focus Settings

● Focus Mode

The **Focus Mode** can be set to **Auto**, **Manual**, **Semi-auto**.

◆ **Auto:**

The speed dome focuses automatically at any time according to objects in the scene.

◆ **Semi-auto:**

The speed dome focuses automatically only once after panning, tilting and zooming.

◆ **Manual:**

In **Manual** mode, you need to use   on the control panel to focus manually.

● **Min. Focus Distance**

This function is used to limit the minimum focus distance. The value can be set to 1.5m, 3m, 6m, 10cm and 50cm.



The minimum focus value varies depending on the models of speed dome.

Day/Night Switch

● **Day/Night Switch**

The **Day/Night Switch** mode can be set to **Auto**, **Day** and **Night**.

◆ **Auto:**

In **Auto** mode, the day mode and night mode can switch automatically according to the light condition of environment. The switching sensitivity can be set to **Low**, **Normal**, **High**.



Figure 6-33 Auto Mode Sensitivity

◆ **Day:**

In **Day** mode, the speed dome displays color image. It is used for normal lighting conditions.

◆ **Night:**

In **Night** mode, the image is black and white. **Night** mode can increase the sensitivity in low light conditions.

◆ **Schedule:**

In **Schedule** mode, you can set the time schedule for day mode as shown in Figure 6-34. The rest time out of the schedule is for night mode.



This function varies depending on the models of speed dome.

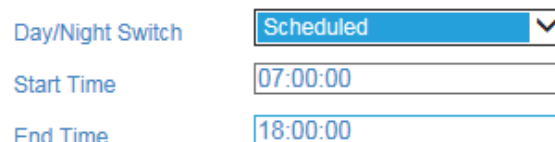

Figure 6-34 Day Night Schedule

● **IR Light Mode**

IR light mode can be set to **Auto** and **Manual**.

◆ **Auto:** The brightness of the infrared light will be adjusted automatically. **IR Light Sensitivity** value ranges from 0 to 100. **Trigger Mode** can be set to **Camera** or

Photosensitive.

- ◆ **Manual:** you need to adjust the brightness value of infrared light manually. **IR Light Bright** value ranges from 0 to 100.



Only the IR speed domes support IR Light Mode.



- When the **IR Light Mode** is auto, the day/night mode is adjusted automatically according to the IR Light Mode. Manually setting the day/night mode is invalid.
- When the **IR Light Mode** is manual and the **IR Light Bright** is 0, you can set the day/night mode manually.
- When the **IR Light Mode** is manual and the **IR Light Bright** is not 0, the night mode is set as the default mode. Manually setting the day/night mode is invalid.

Backlight Settings

- **BLC**

If there's a bright backlight, the subject in front of the backlight appears silhouetted or dark. Enabling **BLC**(back light compensation) function can correct the exposure of the subject. But the backlight environment is washed out to white.

- **WDR (Wide Dynamic Range)**

The wide dynamic range (WDR) function helps the camera provide clear images even under back light circumstances. When there are both very bright and very dark areas simultaneously in the field of view, WDR balances the brightness level of the whole image and provide clear images with details.

You can enable or disable the WDR function as shown in Figure 6-35. The wide dynamic level ranges from 0 to 100.

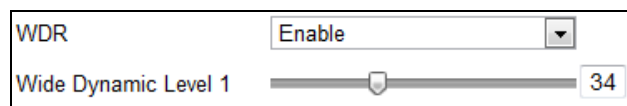

Figure 6-35 WDR



This function varies depending on the models of speed dome.

- **HLC**

HLC (High Light Compensation) makes the camera identify and suppress the strong light sources that usually flare across a scene. This makes it possible to see the detail of the image that would normally be hidden.

White Balance

The **White Balance** mode can be set to **Auto**, **MWB**, **Outdoor**, **Indoor**, **Fluorescent Lamp**, **Sodium Lamp** and **Auto-Track**.

- ◆ **Auto:**

In **Auto** mode, the camera retains color balance automatically according to the current color

temperature.

◆ Manual White Balance:

In **MWB** mode, you can adjust the color temperature manually to meet your own demand as shown in Figure 6-36.



Figure 6-36 Manual White Balance

◆ Outdoor

You can select this mode when the speed dome is installed in outdoor environment.

◆ Indoor

You can select this mode when the speed dome is installed in indoor environment.

◆ Fluorescent Lamp

You can select this mode when there are fluorescent lamps installed near the speed dome.

◆ Sodium Lamp

You can select this mode when there are sodium lamps installed near the speed dome.

◆ Auto-Track

In **Auto-Track** mode, white balance is continuously being adjusted in real-time according to the color temperature of the scene illumination.



This function varies depending on the models of speed dome.

Image Enhancement

● 3D Digital Noise Reduction

You can enable or disable the 3D **Digital Noise Reduction** function as shown in Figure 6-37. The level ranges from 0 to 100.



Figure 6-37 3D Digital Noise Reduction



This function varies depending on the models of speed dome.

Video Adjustment

● Mirror

If you turn the **MIRROR** function on, the image will be flipped. It is like the image in the mirror. The flip direction can be set to OFF or CENTER.



This function varies depending on the models of speed dome.

● Video Standard

You can set the **Video Standard** to 50hz(PAL) or 60hz(NTSC) according to the video system in your

country.



This function varies depending on the models of speed dome.

- **Capture Mode**

You can disable this function or set the value as 1280*720@30fps or 1280*960@30fps.



This function varies depending on the models of speed dome.

Other

- **Lens Initialization**

The lens operates the movements for initialization when you check the check box of **Lens Initialization**.

- **Zoom Limit**

You can set **Zoom Limit** value to limit the maximum value of zooming. The value can be set to 20, 40, 80, 160 and 320.



This function varies depending on the models of speed dome.

6.5.2 Configuring OSD Settings

Purpose:

The speed dome supports following on screen displays:

Time: Supports for time display.

Camera Name: Identifies the name of speed dome.

You can customize the on screen display of time.

Steps:

1. Enter the OSD Settings interface:

Configuration > Advanced Configuration > Image > OSD Settings

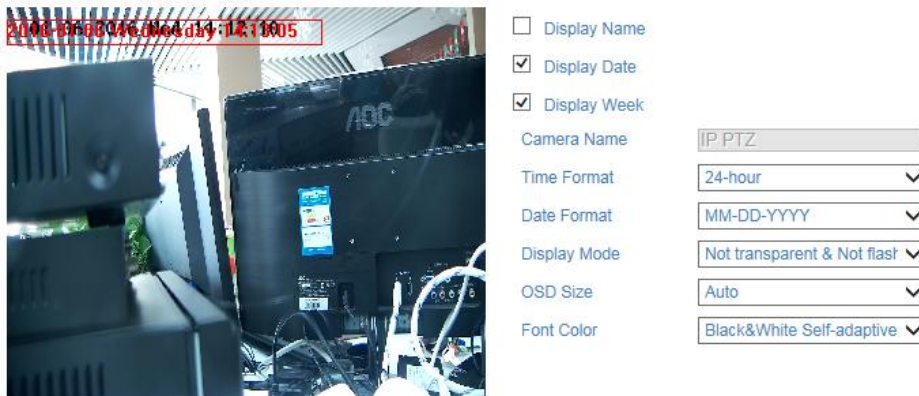

Figure 6-38 OSD Settings

2. Check the corresponding checkbox to select the display of speed dome name, date or week if required.



3. Edit the speed dome name in the text field of **Camera Name**.
4. Select from the drop-down list to set the time format, date format, display mode, OSD size and Font color.
5. You can use the mouse to click and drag the text frame  in the live view window to adjust the OSD position.



Figure 6-39 Adjust OSD Location



6. Click  to activate above settings.

6.5.3 Configuring Text Overlay Settings

Purpose:

You can customize the text overlay.

Steps:

1. Enter the Text Overlay Settings interface:
Configuration > Advanced Configuration > Image > Text Overlay
2. Check the checkbox in front of textbox to enable the on-screen display.
3. Input the characters in the textbox.
4. Use the mouse to click and drag the red text frame  in the live view window to adjust the text overlay position.
5. Click .



There are up to 4 text overlays configurable. When the video resolution is 1080p, only one text overlay is supported. When PTZ direction, preset OSDs are displayed, the text overlay is disabled.

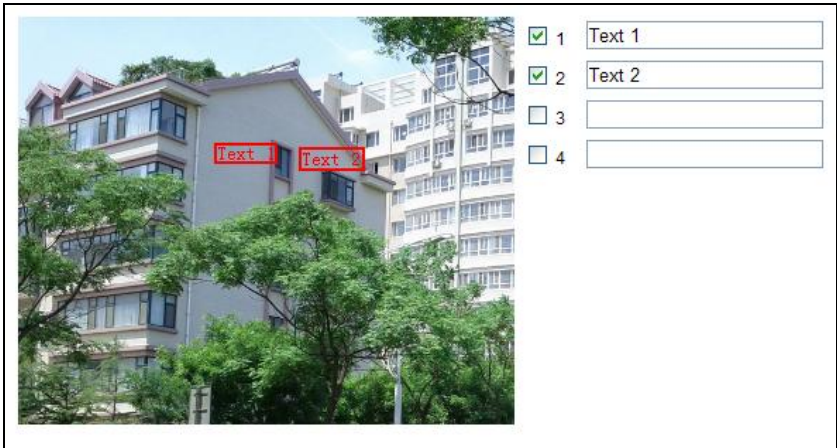

Figure 6-40 Text Overlay Settings

Chapter 7 Playback

Purpose:

This section explains how to view the remotely recorded video files stored in the network disks or SD cards.

Task 1: To play back the video files

Steps:

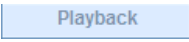
1. Click  on the menu bar to enter playback interface.

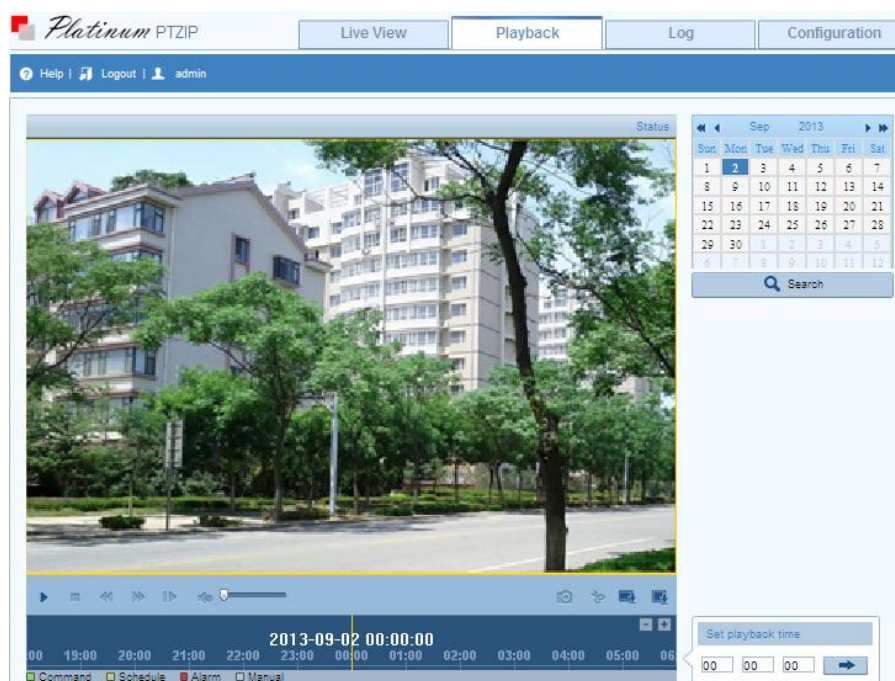
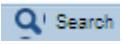

Figure 7-1 Playback Interface

2. Select the date and click .

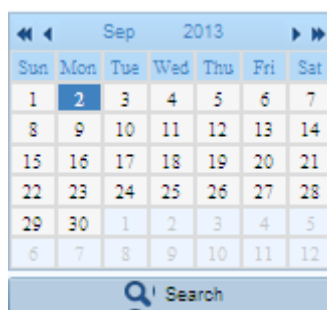



Figure 7-2 Search Video

3. Click  to play the video files found on this date.

The toolbar on the bottom of Playback interface can be used to control playing process.



Figure 7-3 Playback Toolbar

Table 7-1 Description of the buttons

Button	Operation	Button	Operation
	Play		Capture a picture
	Pause		Start/Stop clipping video files
	Stop		Audio on and adjust volume/Mute
	Speed down		Download video files
	Speed up		Download captured pictures
			Playback by frame



You can choose the file paths locally for downloaded playback video files and pictures in Local Configuration interface. Please refer to Section **6.1 Configuring Local Parameters** for details.

Drag the progress bar with the mouse to locate the exact playback point. You can also input the time and click to locate the playback point in the **Set playback time** field. You can also click to zoom out/in the progress bar.

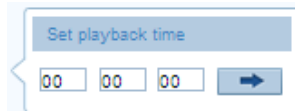

Figure 7-4 Set Playback Time



Figure 7-5 Progress Bar

The different colors of the video on the progress bar stand for the different video types as shown in Figure 7-6.

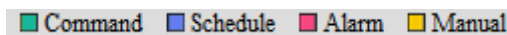



Figure 7-6 Video Types

Task 2: To download the video files

Steps:

1. Click  on the playback interface. The pop-up menu is shown in Figure 7-7.
2. Set the start time and end time. Click **Search**. The corresponding video files are listed on the left.

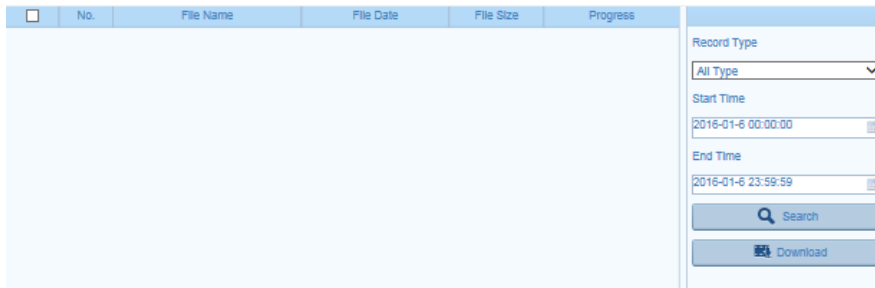



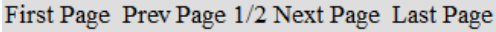

Figure 7-7 Video Downloading interface



3. Check the checkbox in front of the video files that you need to download.
4. Click  to download the video files.



- The progress ratio  displays the downloading ratio of the video file.
- You can click  to stop the downloading.
- The total number  displays the amount of the video files.
- The video files are not all listed on one page. You can click  to turn pages.

Task 3: To download the captured pictures

Steps:

1. Click  on the playback interface. The pop-up menu is shown in Figure 7-8.
2. Set the linkage type of capturing the pictures as timing, alarm, motion, etc..
3. Set the start time and end time. Click **Search**. The corresponding picture files are listed on the left.
4. Check the checkbox in front of the files that you need to download.
5. Click  to download the files.

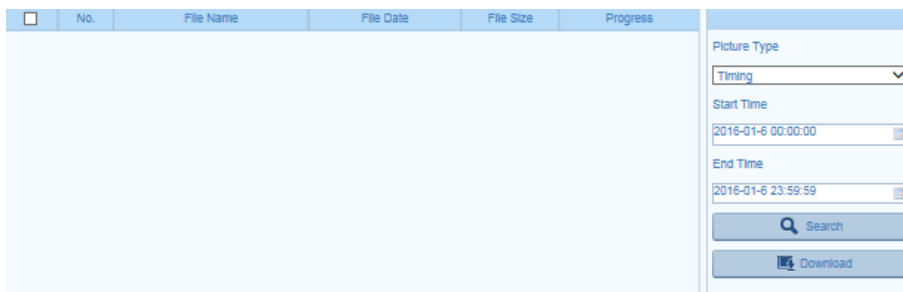

Figure 7-8 Picture Downloading interface

Chapter 8 Log Searching

Purpose:

The operation, alarm, exception and information of the speed dome can be stored in log files. You can also export the log files on your demand.

Before you start:

Please configure network storage for the speed dome or insert a SD card in the speed dome.

Steps:

1. Click  on the menu bar to enter log searching interface.

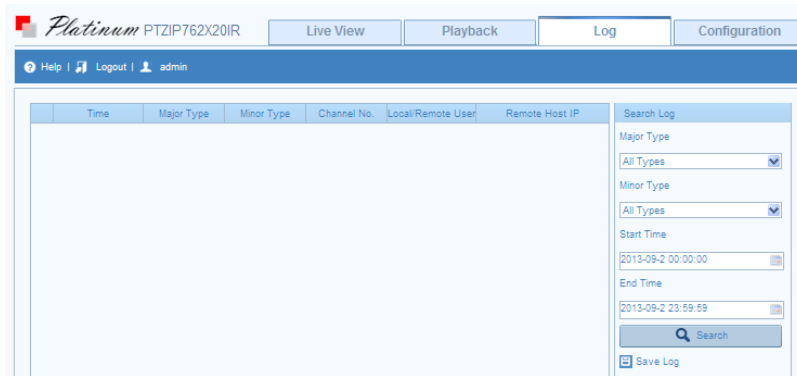
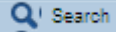

Figure 8-1 Log Searching Interface

2. Set the log search conditions to specify the search, including the Major Type, Minor Type, Start Time and End Time as shown in Figure 8-2.
3. Click  to search log files. The matched log files will be displayed on the **Log** interface.

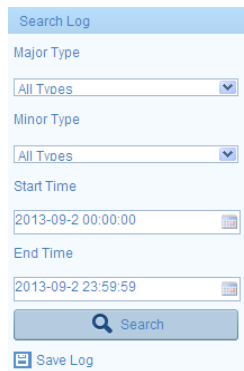

Figure 8-2 Log Searching

4. To export the log files, click  to save the log files in your computer.

Chapter 9 Others

9.1 Managing User Accounts

Enter the User Management interface:

Configuration > Basic Configuration > Security > User

Or **Configuration > Advanced Configuration > Security > User**

The **admin** user has access to create, modify or delete other accounts. Up to 32 user accounts can be created.

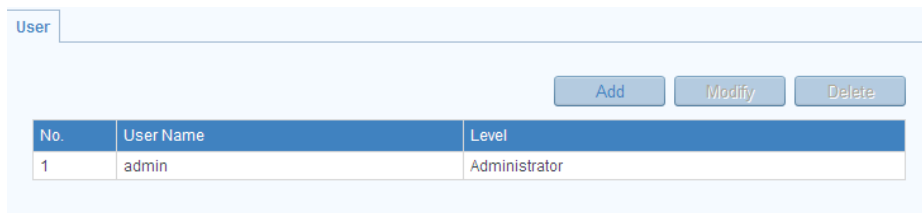

No.	User Name	Level
1	admin	Administrator

Figure 9-1 User Information

- Add a User

Steps:

1. Click **Add** to add a user.
2. Input the new **User Name**, select **Level** and input **Password**.



The level indicates the permissions you give to the user. You can define the user as **Operator** or **User**.

3. In the **Basic Permission** field and **Camera Configuration** field, you can check or uncheck the permissions for the new user.
4. Click **OK** to finish the user addition.

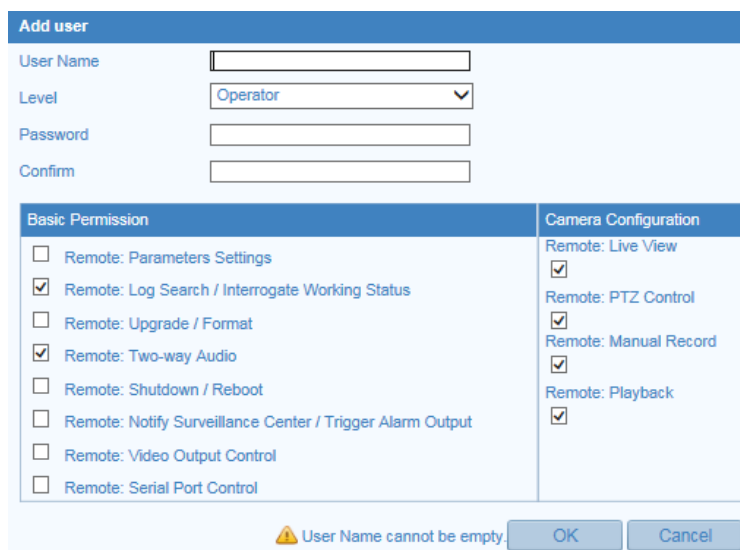

Add user	
User Name	<input type="text"/>
Level	Operator
Password	<input type="text"/>
Confirm	<input type="text"/>
Basic Permission	Camera Configuration
<input type="checkbox"/> Remote: Parameters Settings	Remote: Live View <input checked="" type="checkbox"/>
<input checked="" type="checkbox"/> Remote: Log Search / Interrogate Working Status	Remote: PTZ Control <input checked="" type="checkbox"/>
<input type="checkbox"/> Remote: Upgrade / Format	Remote: Manual Record <input checked="" type="checkbox"/>
<input checked="" type="checkbox"/> Remote: Two-way Audio	Remote: Playback <input checked="" type="checkbox"/>
<input type="checkbox"/> Remote: Shutdown / Reboot	
<input type="checkbox"/> Remote: Notify Surveillance Center / Trigger Alarm Output	
<input type="checkbox"/> Remote: Video Output Control	
<input type="checkbox"/> Remote: Serial Port Control	
⚠ User Name cannot be empty.	
OK Cancel	

Figure 9-2 Add a User

- Modify a User

Steps:

1. Left-click to select the user from the list and click **Modify**.
2. Modify the **User Name**, **Level** or **Password**.
3. In the **Basic Permission** field and **Camera Configuration** field, you can check or uncheck the permissions.
4. Click **OK** to finish the user modification.

Figure 9-3 Modify a User

- Delete a User

Steps:

1. Left-click the user name you want to delete and click **Delete**.
2. Click **OK** on the pop-up dialogue box to delete the user.

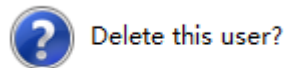

Figure 9-4 Delete a User

9.2 Configuring Authentication Security

Purpose:

You can specifically secure the stream data of live view.

Steps:

1. Enter the Authentication interface:
Configuration > Advanced Configuration > Security > Authentication
2. Set the authentication mode for each authentication type.
RTSP Authentication: Select the authentication mode as basic or disable in the dropdown list to enable or disable the RTSP authentication.
3. Click **Save** to save the settings.

9.3 Configuring Anonymous Visit

Enabling this function allows visit for whom doesn't have the user name and password of the device.



Only live view is available for the anonymous user.

Steps:

1. Enter the Anonymous Visit interface:

Configuration > Advanced Configuration > Security > Anonymous Visit



Figure 9-5 Anonymous Visit

2. Set the **Anonymous Visit** permission **Enable** or **Disable** in the drop-down list to enable or disable the anonymous visit.
3. Click **Save** to save the settings.

There will be a checkbox of Anonymous by the next time you logging in.



Figure 9-6 Login Interface with an Anonymous Checkbox

4. Check the checkbox of **Anonymous** and click **Login**.

By permitting the Anonymous "Live View" function, you may enable others to access your speed dome and view live images without providing login credentials. It therefore is critical when permitting the Anonymous "Live View" function to ensure that your camera's field of view does not impact the privacy of individuals whose images might be captured without authorization.

Given its inherent intrusiveness, video surveillance is inappropriate in areas where people have a higher expectation of privacy.

9.4 Configuring IP Address Filter

With this function on, the camera allows certain IP addresses whether to log in or not.

Filter Type	Description
Forbidden	Forbid the IP addresses added in the IP Address Filter interface to log in.
Allowed	Allow only the IP addresses added in the IP Address Filter

	interface to log in.
<input type="checkbox"/> Enable IP Address Filter	
IP Address Filter Type	Forbidden
IP Address Filter	
	Add
	Modify
	Delete
	Clear
No.	IP

Figure 9-7 IP Address Filter

9.5 Security Service

Steps:

1. Enter the Security Service interface:
Configuration > Advanced Configuration > Security > Security Service
2. Check the checkbox to enable the SSH function.
Enable SSH: Enabling SSH (Secure Shell) function is to encrypt and compress the data and to reduce the transmission time.

9.6 Viewing Device Information

Enter the Device Information interface:

Configuration > Basic Configuration > System > Device Information

Or **Configuration > Advanced Configuration > System > Device Information**

In the **Device Information** interface, you can edit the Device Name.

Other information of the network speed dome, such as Model, Serial No., Firmware Version, Encoding Version, Number of Channels, Number of HDDs, Number of Alarm Input and Number of Alarm Output are displayed. The information cannot be changed in this menu. It is the reference for maintenance or modification in future.

Basic Information	
Device Name	IP PTZ
Device No.	88
Model	PTZIP752X20
Serial No.	PTZIP752X2020131223BBWR446203370C
Firmware Version	V5.3.10 build 151207
Encoding Version	V7.0 build 150831
Number of Channels	1
Number of HDDs	0
Number of Alarm Input	7
Number of Alarm Output	2

Figure 9-8 Device Information

9.7 Maintenance

9.7.1 Rebooting the Speed Dome

Steps:

1. Enter the Maintenance interface:
Configuration > Basic Configuration > System > Maintenance
 Or **Configuration > Advanced Configuration > System > Maintenance:**
2. Click **Reboot** to reboot the network speed dome.



Figure 9-9 Reboot the Device

9.7.2 Restoring Default Settings

Steps:

1. Enter the Maintenance interface:
Configuration > Basic Configuration > System > Maintenance
 Or **Configuration > Advanced Configuration > System > Maintenance**
2. Click **Restore** or **Default** to restore the default settings.



Clicking **Default** restores all the parameters to default settings including the IP address and user information. Please use this button with caution.

Default	
Restore	Reset all the parameters, except the IP parameters and user information, to the default settings.
Default	Restore all parameters to default settings.

Figure 9-10 Restore Default Settings

9.7.3 Importing/Exporting Configuration File

Steps:

1. Enter the Maintenance interface:
Configuration > Basic Configuration > System > Maintenance
Or Configuration > Advanced Configuration > System > Maintenance
2. Click **Browse** to select the local configuration file and then click **Import** to start importing configuration file.



You need to reboot the speed dome after importing configuration file.

3. Click **Export** and set the saving path to save the configuration file in local storage.

Figure 9-11 Import/Export Configuration File

9.7.4 Upgrading the System

Steps:

1. Enter the Maintenance interface:
Configuration > Basic Configuration > System > Maintenance
Or Configuration > Advanced Configuration > System > Maintenance
2. Select Firmware or Firmware Directory.
 - **Firmware:** when you select **Firmware**, you need to find the firmware in your computer to upgrade the device.
 - **Firmware Directory:** You need to find the directory where the firmware locates. The device can find the firmware in the directory automatically.
3. Click **Browse** to select the local upgrade file and then click **Upgrade** to start remote upgrade.



The upgrading process will take 1 to 10 minutes. Please don't disconnect power of the speed dome during the process. The speed dome reboots automatically after upgrading.

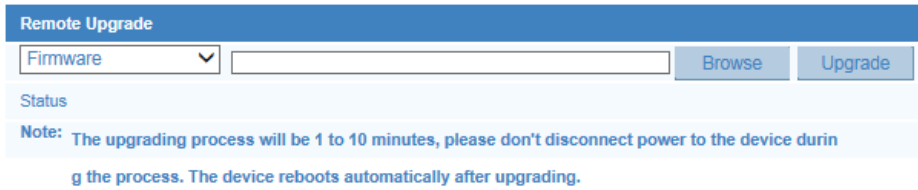

Figure 9-12 Remote Upgrade

9.8 Configuring RS-485

Purpose:

The RS-485 serial port is used to control the PTZ of the camera. The configuring of the PTZ parameters should be done before you control the PTZ unit.

Steps:

1. Enter RS-485 Port Setting interface:

Configuration > Advanced Configuration > System > RS485

Baud Rate	9600 bps
Data Bit	8
Stop Bit	1
Parity	None
Flow Ctrl	None
PTZ Protocol	LTS
PTZ Address	0

Figure 9-13 RS-485 Settings

2. Set the RS-485 parameters and click  to save the settings.



The Baudrate, PTZ Protocol and PTZ Address parameters of the speed dome should be exactly the same as those of the control device.

9.9 Configuring IR Light



The functions vary depending on the models of speed dome

Steps:

1. Enter the interface of configuring the remote connection:
Configuration > Advanced Configuration > System > Service
2. Check the checkbox to enable the IR light function, and then the light will be turned on automatically when the illumination is not enough for the video monitoring.
3. Click the  button to activate the settings.

9.10 Configuring Remote Connection

Steps:

1. Enter the interface of configuring the remote connection:
Configuration> Advanced Configuration> System > Service
2. Input a number in text field as the upper limit of the remote connection number. E.g. when you specify the remote connection number as 10, then the 11th remote connection cannot be established.

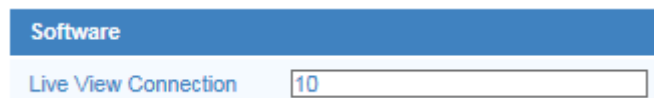

Software	
Live View Connection	10

Figure 9-14 Live View Connection Settings

3. Click the  button to activate the settings.

Appendix

Appendix 1 IP PORTAL Software Introduction

● Description of IP PORTAL

IP PORTAL (Search Active Devices Protocol) is a kind of user-friendly and installation-free online device search tool. It searches the active online devices within your subnet and displays the information of the devices. You can also modify the basic network information of the devices using this software.

● Search active devices online

◆ Search online devices automatically

After launch the IP PORTAL software, it automatically searches the online devices every 15 seconds from the subnet where your computer locates. It displays the total number and information of the searched devices in the Online Devices interface. Device information including the device type, IP address and port number, etc. will be displayed.

ID	Device Type	Security	IPv4 Address	Port	Software Version	IPv4 Gateway	HTTP Port	Device Serial No.
001	LTN8616-P16	Active	192.0.0.64	8000	V3.4.82build 170...	192.0.0.1	80	LTN8616-P16162
002	CMIP8912	Active	192.168.1.146	8000	V5.2.0build 1410...	192.168.1.1	80	CMIP891220141

Figure A.1.1 Searching Online Devices





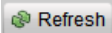

Device can be searched and displayed in the list in 15 seconds after it went online; it will be removed from the list in 45 seconds after it went offline.

◆ Search online devices manually

You can also click  to refresh the online device list manually. The newly searched devices will be added to the list.



You can click  or  on each column heading to order the information; you can click  to expand the device table and hide the network parameter panel on the right side, or click  to show the network parameter panel.

● Modify network parameters

Steps:

1. Select the device to be modified in the device list and the network parameters of the device

will be displayed in the **Modify Network Parameters** panel on the right side.

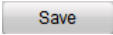
2. Edit the modifiable network parameters, e.g. IP address and port number.
3. Enter the password of the admin account of the device in the **Password** field and click  to save the changes.



- *For your privacy and to better protect your system against security risks, we strongly recommend the use of strong passwords for all functions and network devices. The password should be something of your own choosing (using a minimum of 8 characters, including upper case letters, lower case letters, numbers and special characters) in order to increase the security of your product.*
- *Proper configuration of all passwords and other security settings is the responsibility of the installer and/or end-user.*

Modify Network Parameters

Enable DHCP

Device Serial No.:	LTN8616-P161620160614CCRR611
IP Address:	192.0.0.64
Port:	8000
Subnet Mask:	255.255.255.0
Gateway:	192.0.0.1
IPv6 Address:	fe80::bead:28ff:fe9e:8a38
IPv6 Gateway:	::
IPv6 Prefix Length:	64
HTTP Port:	80

Security Verification

Admin Password:

Modify

[Forgot Password](#)

Figure A.1.2 Modify Network Parameters

Appendix 2 Port Mapping

The following settings are for TP-LINK router (TL-R410). The settings vary depending on different models of routers.

Steps:

1. Select the **WAN Connection Type**, as shown below:

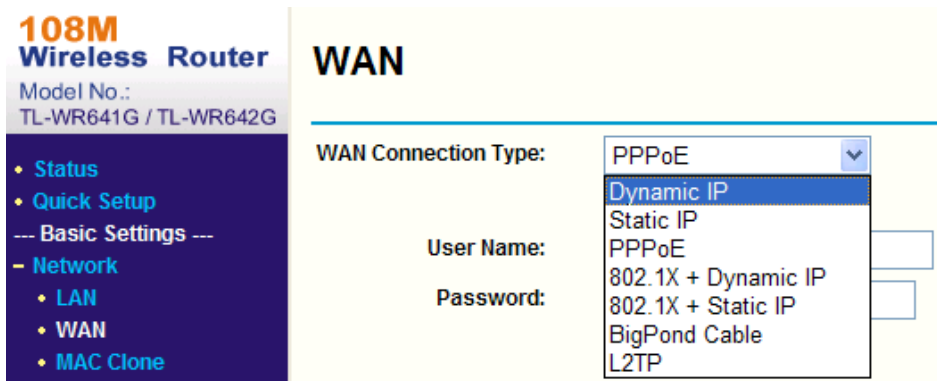

Figure A.2.1 Select the WAN Connection Type

2. Set the **LAN** parameters of the router as in the following figure, including IP address and subnet mask settings.

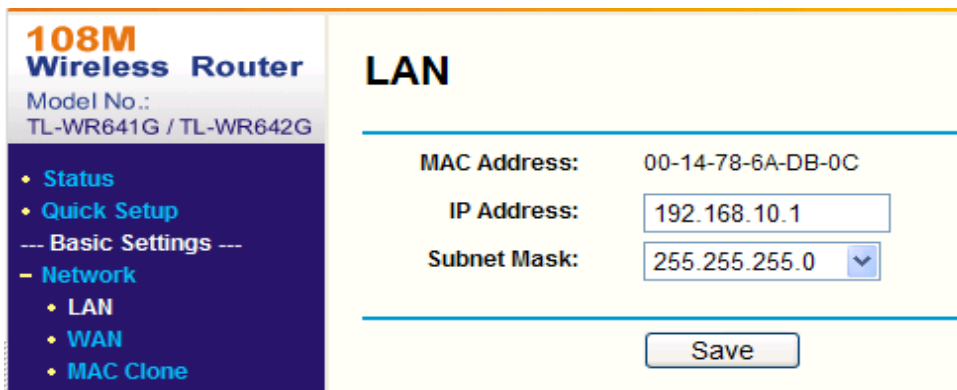

Figure A.2.2 Set the LAN parameters

3. Set the port mapping in the virtual servers of **Forwarding**. You need to forward ports 80, 8000, 8200~8210 and 554 for a speed dome.



- You can change 80, 8000 and 554 ports value in the speed dome with web browser or client software.
- In the speed dome, the 8200~8210 ports change with the 8000 port with a constant value of 200. E.g. if the 8000 port is changed to 8005, then the 8200~8210 ports should be changed to 8205~8215.

Example:

When the speed domes are connected to the same router, you can forward the ports of a speed dome as 80, 8000, 8200~8210 and 554 with IP address 192.168.1.23, and the ports of another speed dome as 81, 8001, 8201~8211 and 555 with IP 192.168.1.24. Refer to the steps as below:

Steps:

1. As the settings mentioned above, forward the port 80, 8000, 8200~8210 and 554 for the network speed dome at 192.168.1.23
2. Forward the port 81, 8001, 8201~8211 and 555 for the network speed dome at 192.168.1.24.
3. Enable **ALL** or **TCP** protocols.
4. Check the **Enable** checkbox and click .

108M Wireless Router
Model No.: TL-WR641G / TL-WR642G

- Status
- Quick Setup
- Basic Settings
- Network
- Wireless
- Advanced Settings
- DHCP
- Forwarding
 - Virtual Servers
 - Port Triggering
 - DMZ
 - UPnP
- Security
 - Static Routing
 - Dynamic DNS
- Maintenance
- System Tools

Virtual Servers

ID	Service Port	IP Address	Protocol	Enable
1	80	192.168.10.23	ALL	<input checked="" type="checkbox"/>
2	8000	192.168.10.23	ALL	<input checked="" type="checkbox"/>
3	554	192.168.10.23	ALL	<input checked="" type="checkbox"/>
4	8200	192.168.10.23	ALL	<input checked="" type="checkbox"/>
5	81	192.168.10.24	ALL	<input checked="" type="checkbox"/>
6	8001	192.168.10.24	ALL	<input checked="" type="checkbox"/>
7	555	192.168.10.24	ALL	<input checked="" type="checkbox"/>
8	8201	192.168.10.24	ALL	<input checked="" type="checkbox"/>

Common Service Port: DNS(53) Copy to ID 1

Previous Next Clear All Save

Figure A.2.3 Port Mapping



The port of the network speed dome cannot conflict with other ports. For example, some web management port of the router is 80. Change the speed dome port if it is the same as the management port.

Appendix 3 Statics, Interference Lightning and Surge Protection

This product adopts TVS plate lightning protection technology to avoid damage caused by pulse signal that is below 3000V, like instantaneous lighting stroke, surging, etc. According to the actual outdoor situation, necessary protection measures must be taken, besides ensuring the electrical safety.

- The distance between signal transmission wires and High-voltage equipment or high-voltage cable is at least 50m.
- Outdoor wiring should better be routed under eaves as much as possible.
- In the open field, wiring should be buried underground in sealed steel pipe, and the steel-pipe should be one-point grounding. Overhead routing method is forbidden.
- In strong thunderstorm area or high induction voltage areas (such as high-voltage transformer substation), high power lightning protection apparatus and lightning conductor are necessary to be added.
- The design of lightning protection and grounding of the outdoor devices and cables should be considered together with the lightning protection demand of buildings. It also must conform to the related national standards and industrial standards.
- The system should be equipotential grounded. The grounding equipment must conform to the demands of system anti-jamming and electrical safety both and it must not appear short circuit or mixed circuit with the zero conductor of strong grid. When the system is grounded alone, the resistance should be no more than 4Ω . The sectional area of the grounding cable should be no less than 25mm^2 . For grounding instructions, please refer to the Installation Manual of Speed Dome.

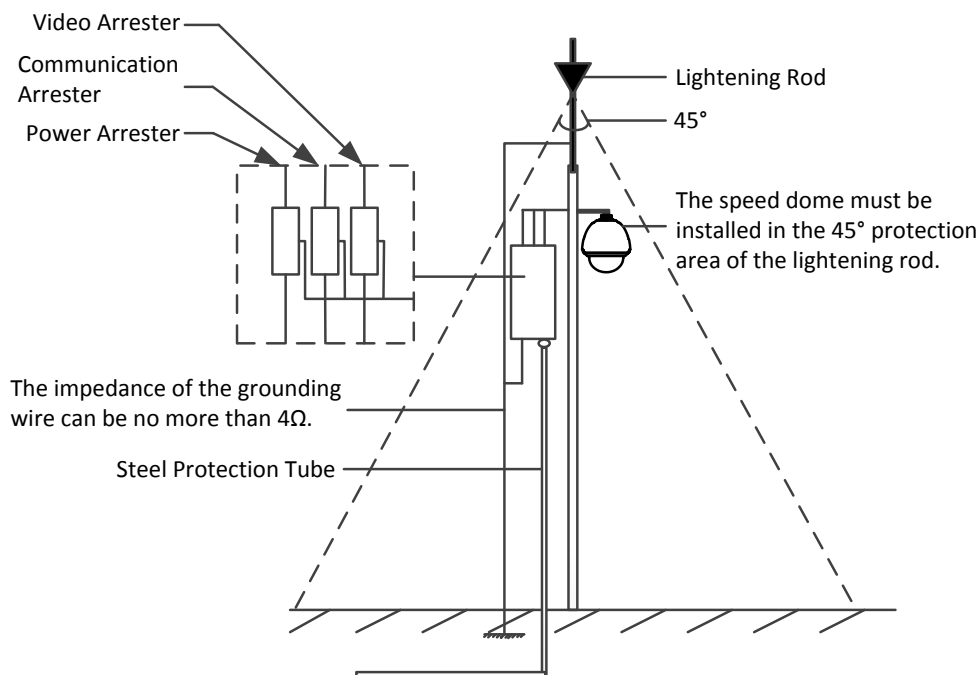

Figure A.3.1 Lightning & Surge Protection

Grounding for Cement Pole/Wall Installation:

When the speed dome is installed in environment where is relatively insulating to the earth, e.g., cement pole or cement wall, then only the control center requires proper grounded locally. Refer to the following figure.

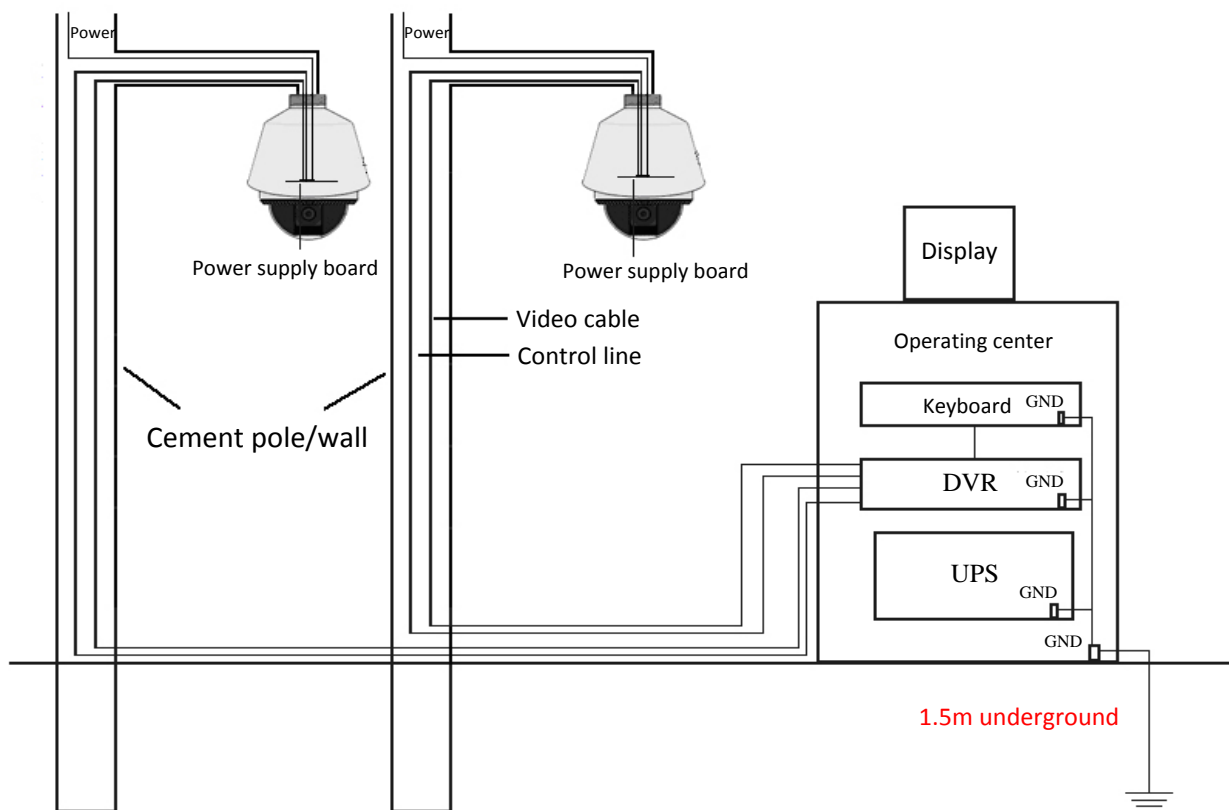

Figure A.3.2 Grounding in Cement Pole/Wall Installation

NOTE

- Because the signal transmission media of fiber optical speed dome and network speed dome are isolated from the control center, they must be grounded locally to protect dome against damages.
- If the dome is installed in strong thunderstorm area, it must be grounded locally to release lightening or suchlike high energy to protect dome against damages. Refer to the following figure.

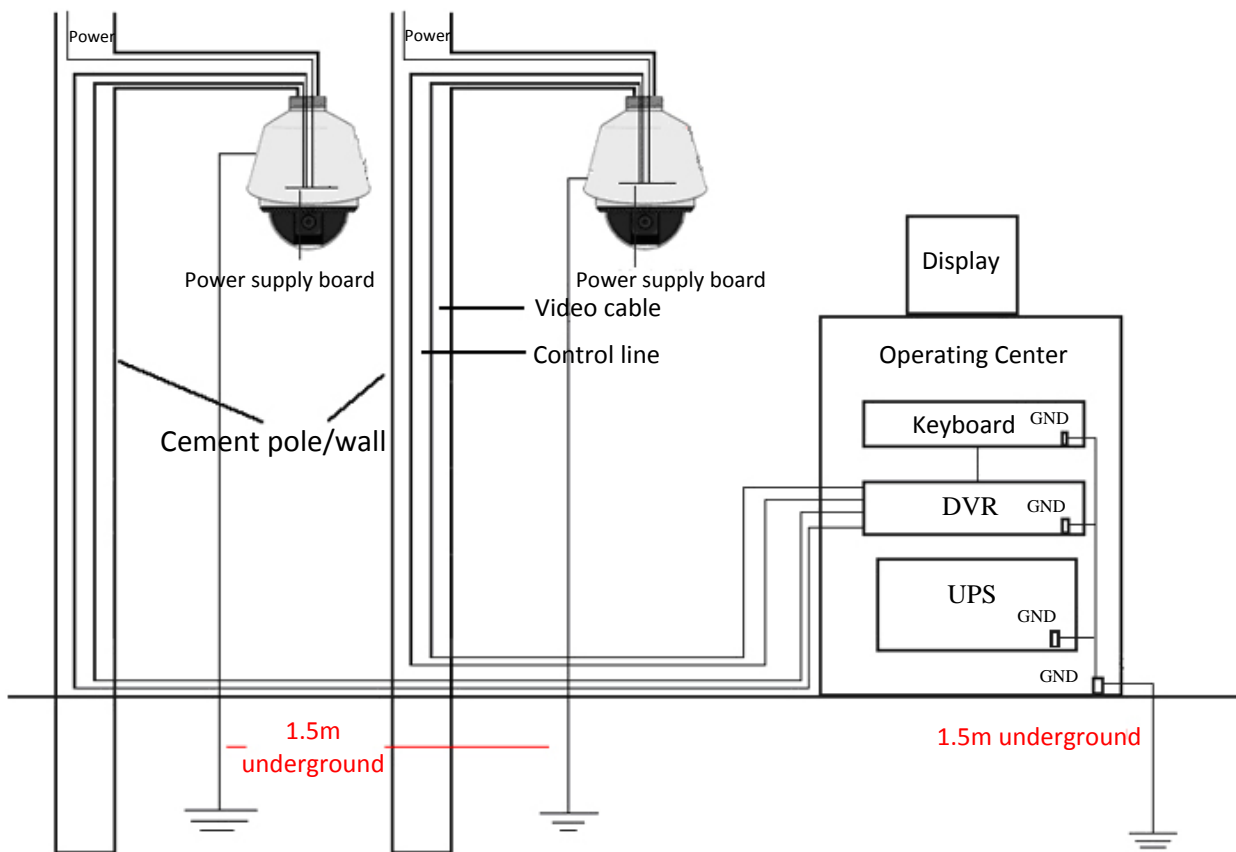

Figure A.3.3 Lightning-protection Grounding in Cement Pole/Wall Installation

Grounding for Metal Pole Installation:

When the speed dome is installed in environment where is conductive to the earth, e.g., metal pole, then the grounding of dome can be achieved by the properly grounded metal pole, meanwhile, the control center must be grounded locally as well. Refer to the following figure.

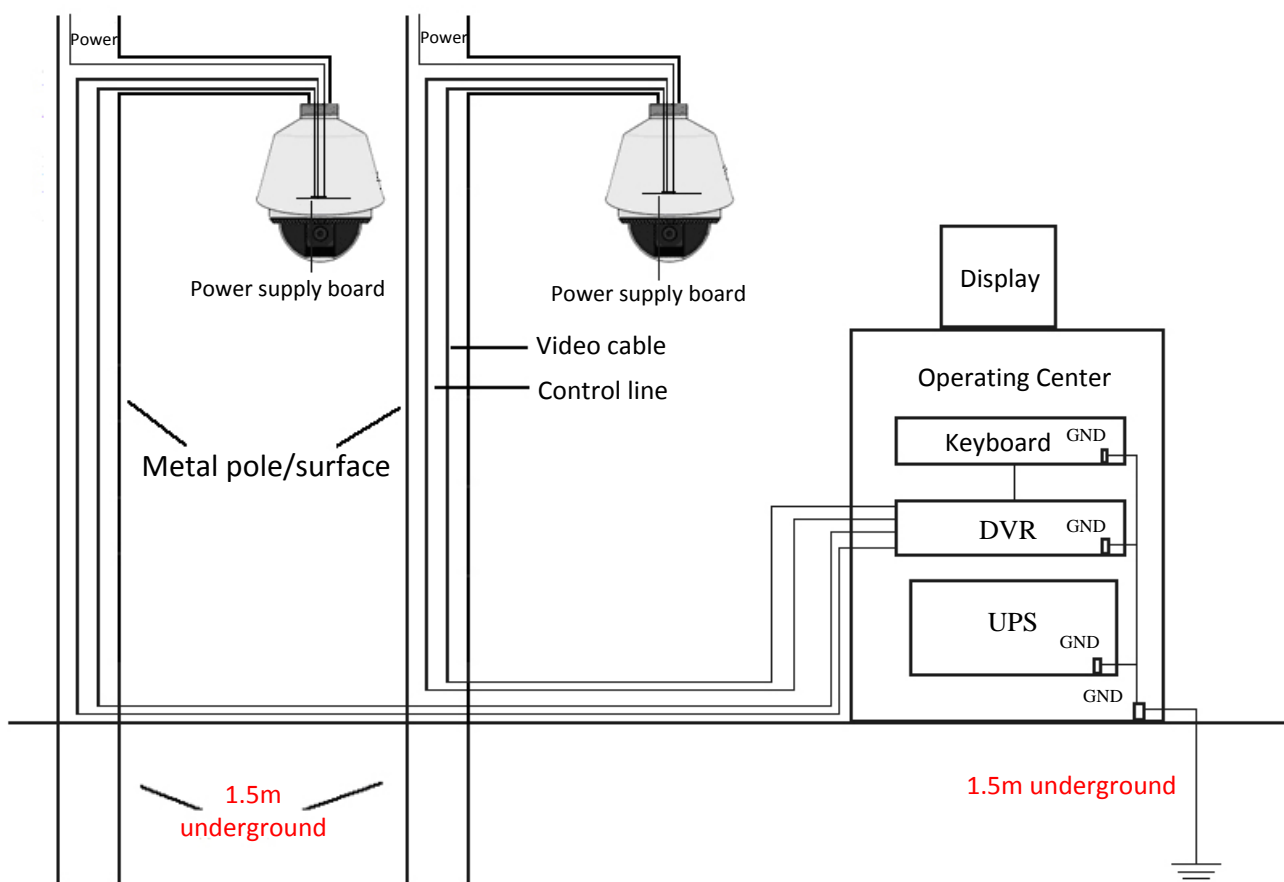

Figure A.3.4 Grounding in Metal Pole Installation

Note: If the fiber optics, lightning protector or other device are applied during the transmission of speed dome, such devices as well as the video cables routing through must be proper grounded.

Appendix 4 Waterproof



- The long-arm wall mount is recommended for the outdoor application of speed dome.
- You cannot use the short-arm wall mount or pendant mount for outdoor application, because it is not water-proof.
- It is recommended to use the mount with inner threaded interface and good waterproof performance.
- If you use a mount with outer threaded interface, please adopt waterproof measures to the adapter applied between the mount and the dome.
- Do not install indoor speed dome to the outdoor environment.

L-shape Pole Mount

Make sure that the L-shape pole mount is designed with a certain inclination angle as shown in following figure. Water won't flow from the pole into the speed dome with the inclination angle.

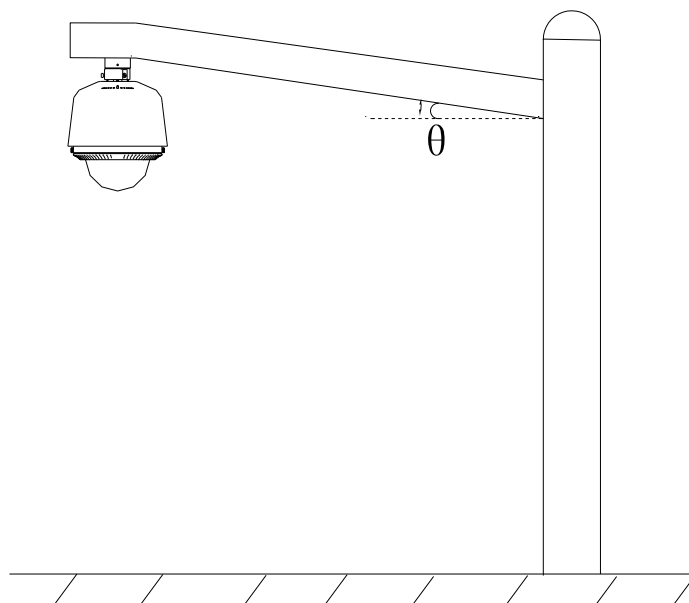

Figure A.4.1 Customized Mount

Appendix 5 Bubble Maintenance

The bubble is a transparent plastic. The dust, oil and finger print, etc. will cause scratch or image blur. Please refer to the following method to clean the bubble.

- Handling dust

Use oil free soft brush or blowing dust ball to clean the dust.

- Handling oil

Steps:

1. Wipe off the water-drop or oil by soft cloth and dry the bubble.
2. Use oil free cotton cloth to wipe the bubble with alcohol or detergent.
3. Change the cloth to wipe the bubble until the bubble is clean.

Appendix 6 RS485 Bus Connection

- General Property of RS485 Bus

According to RS485 industry bus standard, RS485 is a half-duplex communication bus which has 120Ω characteristic impedance, the maximum load ability is 32 payloads (including controller device and controlled device).

- RS485 Bus Transmission Distance

When using 0.56mm (24AWG) twisted-pair line, according to different baudrate, the maximum transmission distance theory table is shown as below:

Max. Distance of RS485 Transmission	
Baudrate	Max Distance
2400BPS	1800m
4800BPS	1200m
9600BPS	800m

The transmission distance will be decreased if we use the thinner cable, or use this product under the strong electromagnetic interference situation, or there are lots of devices are added to the bus; on the contrary, the transmission distance will be increased.

- Connection Methods

RS485 industry bus standard require daisy-chain connection method between any devices, both sides have to connect a 120Ω terminal resistance (show as Diagram 1), the simplified connection method is shown as diagram 2, but the distance of “D” should not be too long.

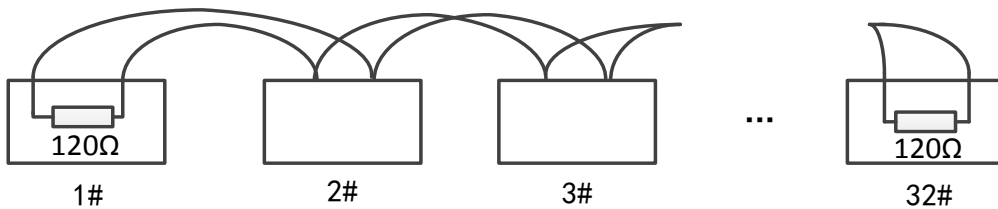

Figure A.6.1 RS485 Connection 1

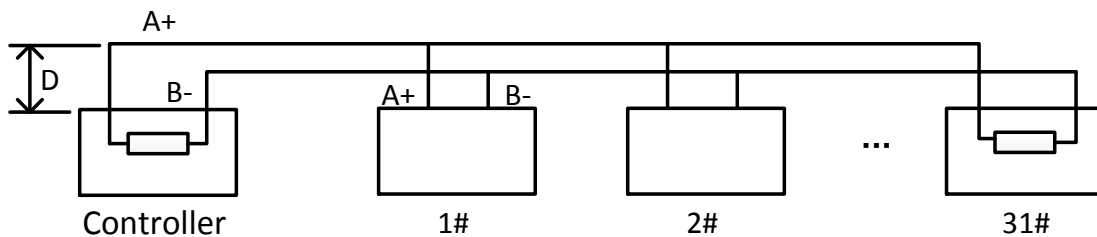

Figure A.6.2 RS485 Connection 2

- Problems in the Practical Application

Normally, users adopt star-shape connection method in construction, under this situation, the terminal resistors must be connected between two farthest devices (as Figure A-9, 1# and 15#), but this connection method is not satisfy the requirement of the RS485 industry standard so that it will lead to some problems such as signal reflection, anti-jamming ability decline when the devices are faraway. At this time, the dome will be uncontrollable, or self-running, etc.

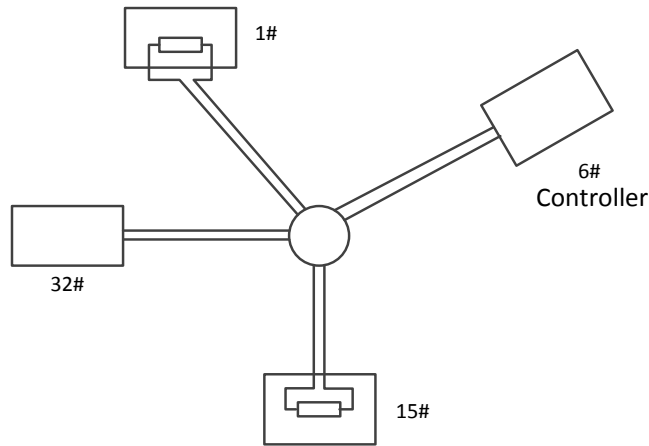

Figure A.6.3 Star Shape Connection

For such case, the best way is adding a RS485 distributor. This product can effectively change the star-shape connection to which satisfies the requirement of RS485 industry standard, in order to avoid those problems and improve the communication reliability. Refer to the following figure.

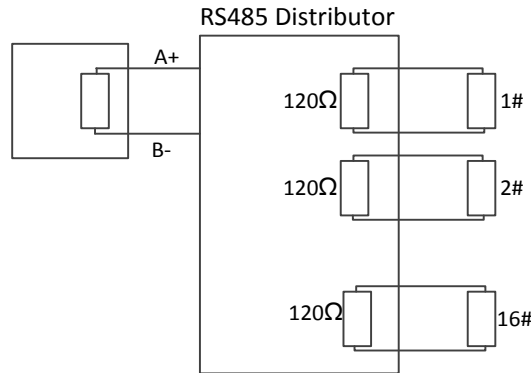

Figure A.6.4 RS485 Distributor

● Troubleshooting of RS485 communication

Problem	Possible Reasons	To Solve the Problem
The speed dome does the self-test action but cannot be controlled remotely.	1. The address or baudrate of the speed dome does not match with those of remote control device.	1. Adjust the address and baudrate of the remote control device to match with those of the speed dome.
	2. The wire RS485+ connects to the interface RS485- and wire RS485- connects to the interface RS485+.	2. Connect the wire RS485+ to the interface RS485+ and wire RS485- to the interface RS485-.
	3. The RS485 wire is disconnected.	3. Reconnect the RS485 wire tightly.
	4. RS485 wire is broken.	4. Change a RS485 wire.
The speed dome can be controlled but not smoothly.	1. The connection is loose.	1. Reconnect the RS485 wire tightly.
	2. RS485+ or RS485-wire is broken.	2. Change a RS485 wire.
	3. The speed dome is too far away from the remote control device.	3. Add a terminal resistor.
	4. Too many speed domes are connected.	4. Add a RS485 distributor.

Appendix 7 24VAC Wire Gauge & Transmission Distance

The following table describes the recommended max. distance adopted for the certain wire gauge when the loss rate of 24VAC voltage is less than 10%. For the AC driven device, the maximum voltage loss rate is 10% allowable. For example, for a device with the rating power of 80VA which is installed at a distance of 35 feet (10m) away from the transformer, then 0.8000mm is required as the minimum wire gauge.

Distance (feet) Wire Gauge (mm) Power (va)	0.8000	1.000	1.250	2.000
10	283(86)	451(137)	716(218)	1811(551)
20	141(42)	225(68)	358(109)	905(275)
30	94(28)	150(45)	238(72)	603(183)
40	70(21)	112(34)	179(54)	452(137)
50	56(17)	90(27)	143(43)	362(110)
60	47(14)	75(22)	119(36)	301(91)
70	40(12)	64(19)	102(31)	258(78)
80	35(10)	56(17)	89(27)	226(68)
90	31(9)	50(15)	79(24)	201(61)
100	28(8)	45(13)	71(21)	181(55)
110	25(7)	41(12)	65(19)	164(49)
120	23(7)	37(11)	59(17)	150(45)
130	21(6)	34(10)	55(16)	139(42)
140	20(6)	32(9)	51(15)	129(39)
150	18(5)	30(9)	47(14)	120(36)
160	17(5)	28(8)	44(13)	113(34)
170	16(4)	26(7)	42(12)	106(32)
180	15(4)	25(7)	39(11)	100(30)
190	14(4)	23(7)	37(11)	95(28)
200	14(4)	22(6)	35(10)	90(27)

Appendix 8 12VDC Wire Gauge & Transmission Distance

The following table describes the recommended max. distance adopted for the certain wire gauge when the loss rate of 12VDC voltage is less than 15%. For the DC driven device, the maximum voltage loss rate is 15% allowable.

Distance (feet) / Wire Gauge (mm)	0.800(20)	1.000(18)	1.250 (16)	2.000(12)
Power (va)	97(28)	153(44)	234(67)	617(176)
10	49(14)	77(22)	117(33)	308(88)
20	41(12)	64(18)	98(28)	257(73)
30	32(9)	51(15)	78(22)	206(59)
40	24(7)	38(11)	59(17)	154(44)
48	20(6)	32(9)	49(14)	128(37)
50	19(6)	31(9)	47(13)	123(35)
60	16(5)	26(7)	39(11)	103(29)
70	14(4)	22(6)	33(10)	88(25)
80	12(3)	19(5)	29(8)	77(22)
90	10.8(3.1)	17(5)	26(7)	69(20)
100	9.7(2.8)	15(4)	23(7)	62(18)
110	8.9(2.5)	14(4)	21(6)	56(16)
120	8.1(2.3)	13(4)	20(6)	51(15)
130	7.5(2.1)	11.8(3.4)	18(5)	47(14)
140	7(2)	11(3.1)	17(5)	44(13)
150	6.5(1.9)	10.2(2.9)	16(4)	41(12)
160	6.1(1.7)	9.6(2.7)	15(4)	39(11)
170	5.7(1.6)	9(2.6)	14(4)	36(10)
180	5.4(1.5)	8.5(2.4)	13(4)	34(10)

Appendix 9 Table of Wire Gauge Standards

Bare Wire Gauge(mm)	American Wire Gauge AWG	British Wire Gauge SWG	Cross-sectional Area of Bare Wire(mm ²)
0.750	21		0.4417
0.800	20	21	0.5027
0.900	19	20	0.6362
1.000	18	19	0.7854
1.250	16	18	1.2266
1.500	15	17	1.7663
2.000	12	14	3.1420
2.500			4.9080
3.000			7.0683

Appendix 10 Alarm In/Out Connections



This section is only for the speed domes with alarm in/out functions.
The speed dome can be connected with alarm inputs (0~5VDC) and alarm outputs. Refer to the following diagrams for alarm output:

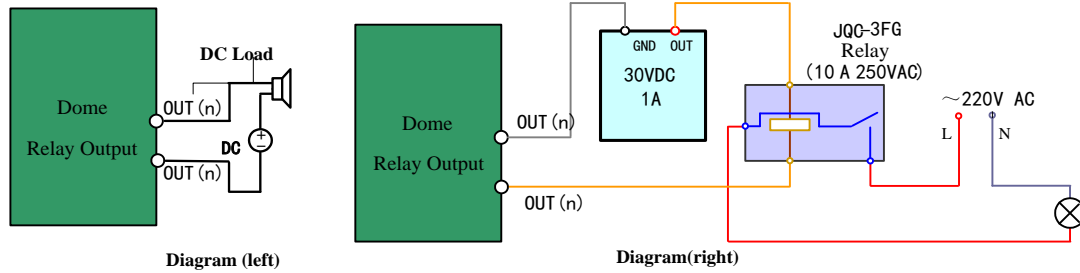

Figure A.10.1 Alarm Out Connections

The alarm provides the relay output (no voltage), and the external power supply is required when it connects to the alarm device.

- For DC power supply (left diagram), the input voltage must be no more than 30VDC, 1A.
For AC power supply, the external relay must be used (right diagram) to prevent damages to the speed dome and avoid risk of electric shock.