

# **User Manual of PTZKB835 Keyboard**

**V1.1.0**

## Preventive and Cautionary Tips

Before connecting and operating your keyboard, please be advised of the following tips:

- Ensure unit is placed in a well-ventilated, dust-free environment.
- Keep all liquids away from the keyboard.
- Please check the power supply to avoid the damage caused by voltage mismatch.
- Please make sure the keyboard work in the allowed range of temperature and humidity.
- Please keep the device horizontal and avoid the installation under severe vibration environment.
- The dust board will cause a short circuit after damping. Please dedust regularly for the board, connector, and chassis fan with brush.

## Contents

Chapter 1	Product Overview .....	3
Chapter 2	Device Appearance .....	5
2.1	Rear Panel Description .....	5
2.2	Front Panel Description .....	6
2.3	Joystick Function .....	7
2.4	Typical Wiring Methods .....	8
Chapter 3	Keyboard Operation .....	13
3.1	Controlling DVR by Keyboard .....	13
	Setting the Keyboard Parameters to Control DVR .....	13
	Operating DVR by Keyboard .....	14
3.2	Controlling Dome Cameras by Keyboard .....	16
	Setting the Keyboard Parameters to Control Dome Camera .....	16
	Dome Camera Control Operation .....	17
3.3	Controlling the VMS by Keyboard .....	18
	Setting the Keyboard Parameters to Control VMS .....	18
	VMS Control Operation .....	18
3.4	Controlling the Analog Matrix by Keyboard .....	20
	Setting the Keyboard Parameters to Control Analog Matrix .....	20
	Analog Matrix Controlling Operation .....	20
Appendix 1:	Specification .....	21

# Chapter 1 Product Overview

PTZKB835 keyboard can be used to control the DVR, the analog dome, the video management platform and the analog matrix. The keyboard is featured in its steady and friendly operation.

## Multiple Controlling Modes

The keyboard controls the DVR, Dome Camera, VMS and Analog Matrix.

Controlling modes determine the devices controlled by the keyboard; e.g. if you choose the control mode as DVR, all the commands and the controlling signal will be applied to the DVR. The controlling mode of the PTZKB835 keyboard can be shifted by pressing the MODE button on the panel.

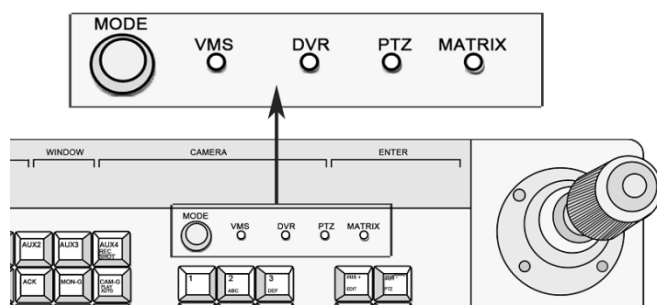

Figure 1-1 Mode Buttons

- **DVR controlling:** The keyboard can fulfill the complete function of the front panel operation of the DVR. And there are LED screen displays for all the operation. One keyboard can connect to 128 DVRs and the address code of the DVR ranges from 0 to 255.
- **Analog Dome Controlling:** The keyboard controls the PTZ function of the analog domes, the address code of the dome ranges from 0 to 255. A maximum 128 analog domes can be connected.
- **VMS Controlling:** The keyboard controls the video management platform, the TV wall switching and display, PTZ parameters setting and PTZ controlling.
- **Analog Matrix Controlling:** Control the signal input and output switch in the analog matrix.

## Multiple Working Modes

The working modes are chosen by turning the key on the front panel. See the figure below.

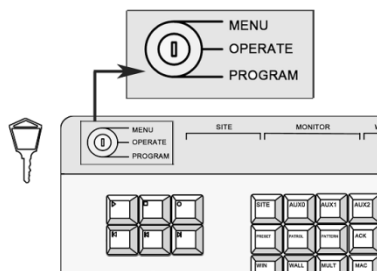

Figure 1-2 Turning the Key to Change Working Mode

- **MENU:** Keyboard Configuration Mode. Turn the key to the **MENU**. Set the keyboard parameters, such as the keyboard address, the RS-485 parameters and the RS-232 parameters.
- **OPERATE:** Keyboard Operation Mode. Turn the key to **OPERATE**. Under this mode, the keyboard can control the DVR, PTZ of the dome camera and the matrix.
- **PROGRAM:** Keyboard Function Settings Mode. Turn the key to **PROGRAM**. Under this mode, the keyboard can set the parameters for preset, pattern and patrol.

## Protocols

There are 62 protocols of the PTZ control of dome camera, and the main protocols are PELCO-P, PELCO-D, SAMSUNG, YAAN-1, SONY, SIEMENS, DRAGON, NAIJIE, KALATEL, VICON and etc..

The control protocols for the analog matrix are ZT-1.0, ZT-2.0, EXTRON, and CREATOR.

## Cascade Connection

PTZKB835 provides the cascade connection, and 16 auxiliary keyboards are connectable. The address of the auxiliary keyboard ranges from 0 to 255.

## Other Features

- The keyboard can set different RS485 parameters such as the protocol and the Baudrate, which enables the flexible parallel connection to different devices.
- The convenient key locking function ensures the security of operation.
- The keyboard integrates multiple control functions as the controlling of DVR, analog dome cameras and matrix. It can be used in the complex surveillance system.
- LED panel display is provided.

## Chapter 2 Device Appearance

### 2.1 Rear Panel Description

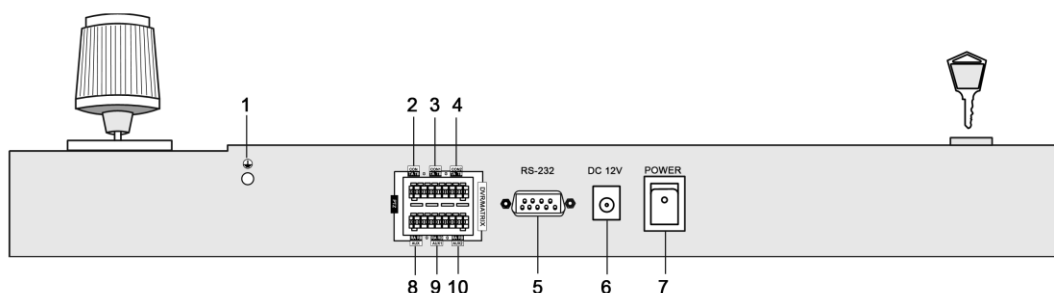

Figure 2-1 The Rear Panel of PTZKB835 Keyboard

**Notes:**

The green end with a **G** identifier on the rear panel is for grounding.

Number	Physical Interfaces	Description
1	Grounding	The pillar for grounding.
2	PTZ-CON (PTZ Control Signal Output)	As main keyboard: Connect the dome camera or the RS485 of the PTZ: <b>TA</b> connects to <b>RS485+</b> , and <b>TB</b> connects to <b>RS485-</b> . As auxiliary keyboard: Connect the PTZ-AUX interface of the upper level keyboard: <b>TA</b> connects to <b>RA</b> and <b>TB</b> connects to <b>RB</b> .
3	DVR/MATRIX-CON1 (DVR Control Signal Output)	As main keyboard: Connect the DVR KB interface; <b>TA</b> connects <b>D+</b> , <b>TB</b> connects <b>D-</b> ; When connecting the RS-485 of the VMS: <b>TA</b> connects to the 6 <sup>th</sup> pin and <b>TB</b> connects to 5 <sup>th</sup> pin. When using the RS-485-to-RS-232 interface: <b>TA</b> connects to 4 <sup>th</sup> pin and <b>TB</b> connects to 3 <sup>rd</sup> pin. As auxiliary keyboard: Connect the AUX2 interface of the upper level keyboard. <b>TA</b> connects to <b>RA</b> and <b>TB</b> connects to <b>RB</b> .
4	DVR/MATRIX-CON2 (Control Signal Output)	Output the RS-485 signal received by the 9 <sup>th</sup> interface identified in the figure above (AUX 1 interface).
5	RS232 Serial Interface	For the keyboard firmware upgrading and the control interface for the analog matrix.
6	Power Supply	12VDC
7	Power Switch	Power on/ off
8	PTZ-AUX (Auxiliary keyboard PTZ control signal input)	Connect to the lower level PTZ-CON interface; <b>RA</b> connects to <b>TA</b> and <b>RB</b> connects to <b>TB</b> .
9	DVR/MATRIX-AUX1 (Auxiliary keyboard DVR control signal input)	Connect a RS-485 signal source to receive the RS-485 signal.
10	DVR/MATRIX-AUX2 (Auxiliary keyboard control signal input)	Connect to the DVR/MATRIX-CON interface of the lower level keyboard: <b>RA</b> connects to <b>TA</b> , <b>RB</b> connects to <b>TB</b> .

We name the keyboard directly connecting the main keyboard *upper level keyboard* and we call the keyboard connecting to the upper level keyboard the *lower level keyboard*. For detailed information, see Chapter 2.4 for typical wiring methods.

## 2.2 Front Panel Description

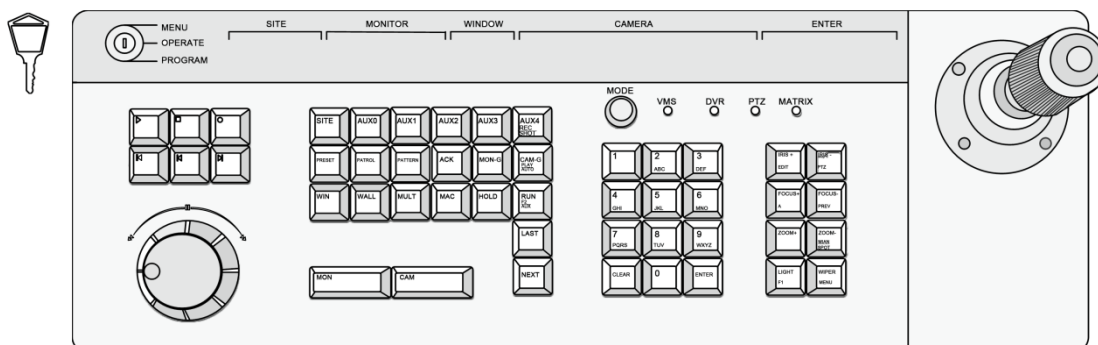

Figure 2-2 Top View on PTZKB835 Keyboard







**Note:**

Buttons on the keyboard have different functions in different controlling modes. For example, the **IRIS+/EDIT** button realizes the **IRIS+** in PTZ control mode and in the DVR control mode, it is the EDIT button, when pressing, you can edit the combobox field.

Button	Description
<b>Lock</b>	Switch to change the working mode of the keyboard.
<b>Playback Buttons</b>	Reserved
<b>Jog Shuttle Button</b>	Reserved
<b>SITE</b>	Press this button to enter the DVR No., dome camera No., analog matrix No. or the VMS No..
<b>AUX0</b>	When controlling VMS, call the patrol of the dome camera.
<b>AUX1</b>	Reserved
<b>AUX2</b>	Reserved
<b>AUX3</b>	Reserved
<b>AUX4/ REC/SHOT</b>	DVR control mode: Audio on/ off and
<b>PRESET</b>	Set and call the preset
<b>PATROL</b>	Set and call the patrol
<b>PATTERN</b>	Set and call the pattern
<b>ACK</b>	Reserved
<b>MON-G</b>	When controlling VMS, choose the monitor group.
<b>CAM-G/PLAY/AUTO</b>	When controlling VMS, choose the camera group.
	DVR control mode: Fast play when playing back.
<b>WIN</b>	When controlling VMS, press the button to choose windows.
<b>WALL</b>	When controlling VMS, select the TV wall after montage is done.
<b>MULT</b>	When controlling VMS, select the small screen which has not been montaged.
<b>MAC</b>	Reserved
<b>HOLD</b>	Stop cycling
<b>RUN/F2/AUX</b>	Start or Go on the cycling

Button	Description
	DVR control mode: change the tab menu
<b>NEXT</b>	The next item, can be a channel or menu setting field.
<b>LAST</b>	The previous item, can be a channel or menu setting field.
<b>MON</b>	When controlling the VMS or analog matrix, press this button to choose the monitor.
<b>CAM</b>	When controlling the VMS or analog matrix, press this button to choose the camera.
<b>MODE</b>	Press to switch the control mode of the keyboard
<b>Numeric &amp; characters buttons (0-9)</b>	Input the number or character; choose the live view or playback channel.
<b>CLEAR</b>	Clear the numbers input and exit.
<b>ENTER</b>	Enter
<b>IRIS+/EDIT</b>	PTZ control mode: iris+
	DVR control mode: enable editing
<b>IRIS-/PTZ</b>	PTZ control mode: iris-
	DVR control mode: show the PTZ control menu
<b>FOCUS+/A</b>	PTZ control mode: focus+
	DVR control mode: switch the input methods
<b>FOCUS-/PREV</b>	PTZ control mode: focus-
	DVR control mode: switch the screen display.
<b>ZOOM+</b>	PTZ control mode: zoom+
<b>ZOOM-/ MAIN/SPOT</b>	PTZ control mode: zoom-
	DVR control mode: switch between main and auxiliary mode
<b>LIGHT/F1</b>	PTZ control mode: turn on the light
<b>WIPER/MENU</b>	PTZ control mode: enable wiper
	DVR control mode: open the main men

## 2.3 Joystick Function

Graphic	Operation	Function
	Up	PTZ control mode: Move the PTZ up.
		DVR control mode: Fast Play when playback, or navigate to the previous item when operating the menu.
	Down	PTZ control mode: Move the PTZ down.
		DVR control mode: Slow play when playback, or navigate to the next item when operating the menu.
	Left	PTZ control mode: Move the PTZ to the left.
		DVR control mode: Skip backward when playback, or navigate to the previous menu when operating the menu.
	Right	PTZ control mode: Move the PTZ right.
		DVR control mode: Skip forward when playback, or navigate to the next menu when operating the menu.
	Left Rotate	Zoom in
	Right Rotate	Zoom out

### Notes :

The joystick realizes pan and tilt movement at 8 directions.

The 4-axis joystick can be used to control the zoom; and the central button used as Enter button and to realize picture capture as well.



## 2.4 Typical Wiring Methods

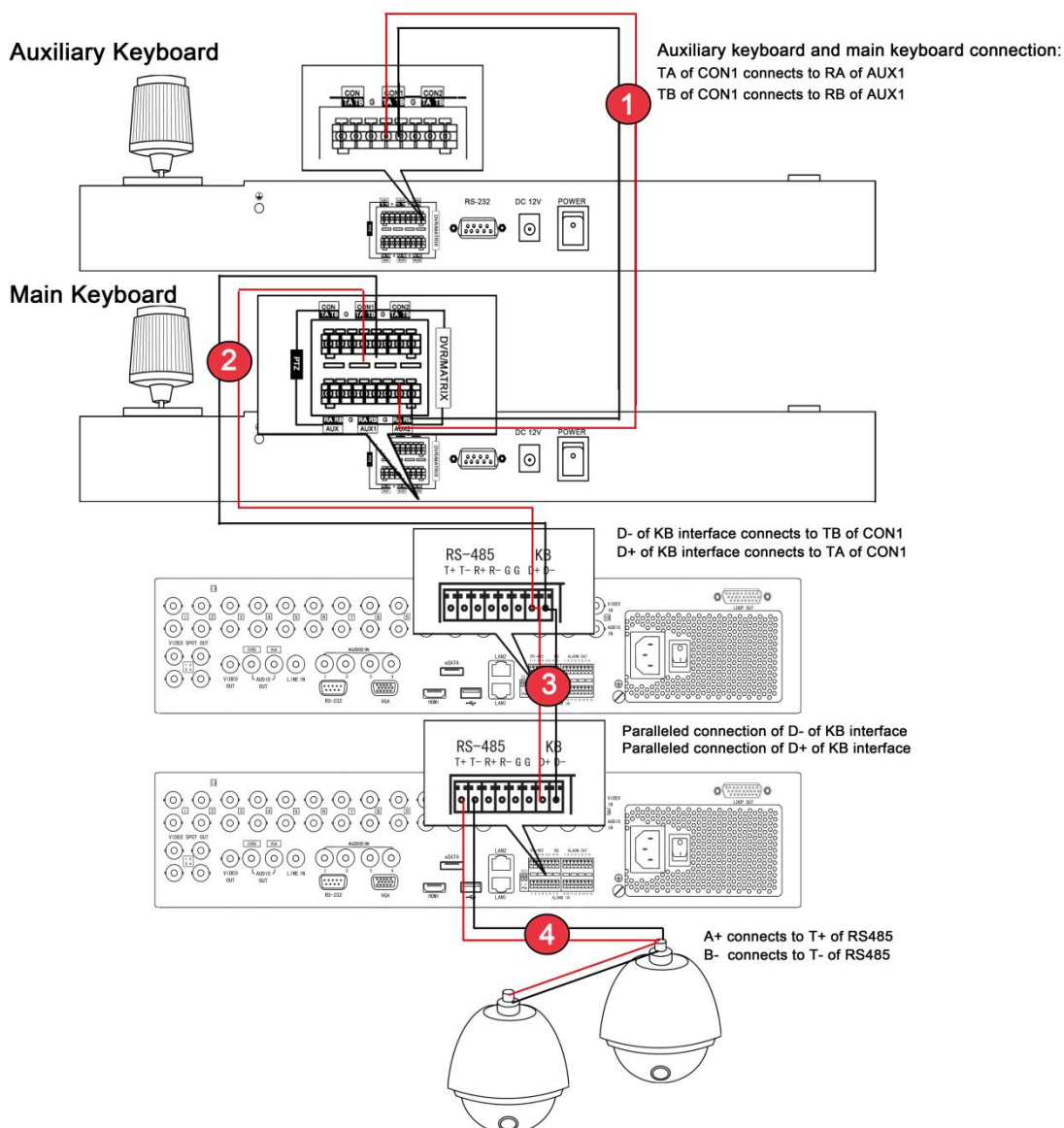

Figure 2-3 Connection between the keyboards, the keyboards and the dome camera, the keyboard and the DVRs

- ① shows the connection of the auxiliary keyboard and the main keyboard. You can connect many auxiliary keyboards to the main keyboard.
- ② shows the connection between the keyboard and the DVR/NVR.
- ③ shows the connection of DVRs when they are all connected and controlled by the keyboard.
- ④ shows the connection between DVR and dome cameras.

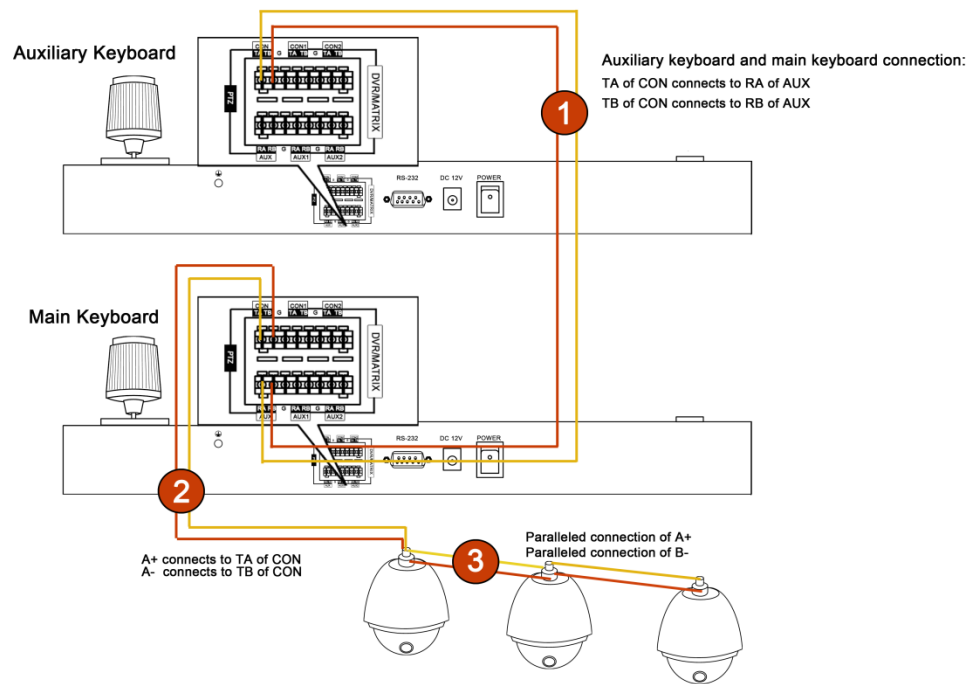

Figure 2-4 Connection between the main and auxiliary keyboards, and the keyboards and the dome camera

- ① shows the connection of the auxiliary keyboard and the main keyboard. You can connect many auxiliary keyboards to the main keyboard.
- ② shows the connection between keyboard and dome camera.
- ③ shows the connection between dome cameras when they are all connected and controlled by the keyboard.

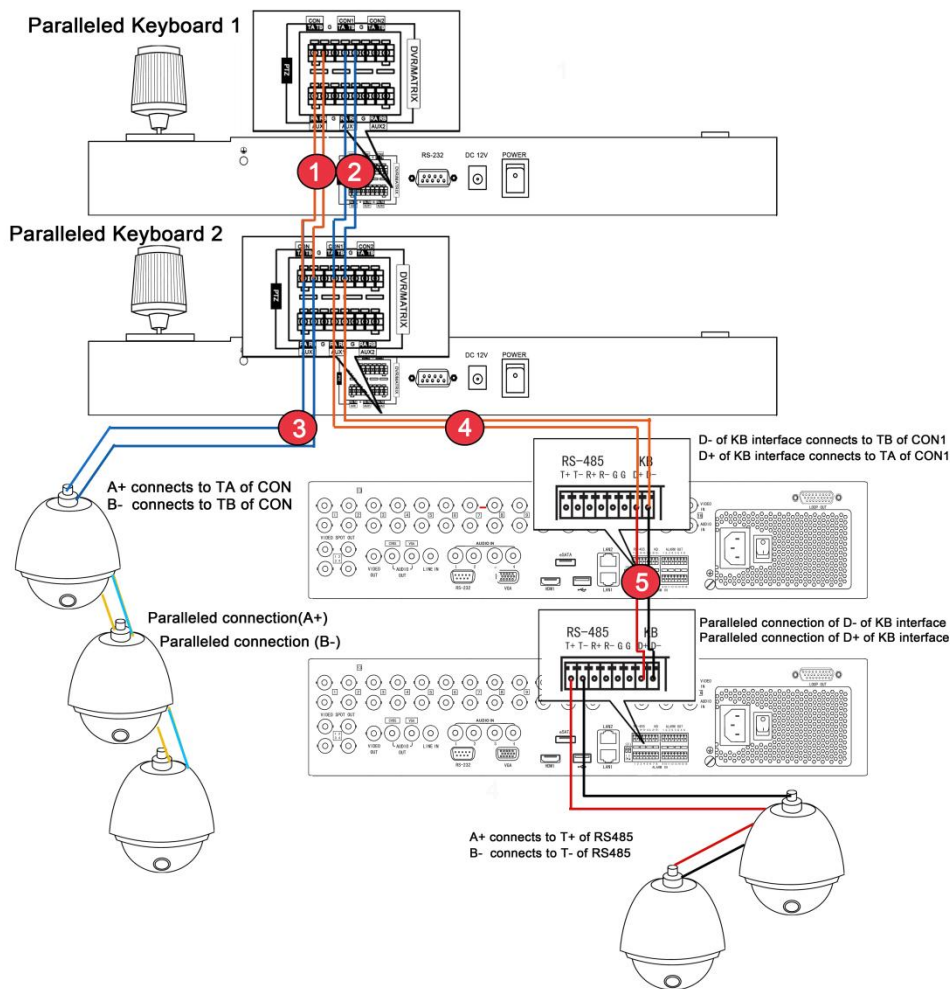

Figure 2-5 Connection between the paralleled keyboards, the keyboards and the dome camera, the keyboard and the DVRs

- ① shows the connection of keyboard when they are connected to each other to control the dome camera. PTZ-CON interface: TA connects TA, TB connects TB.
- ③ shows the connection between the keyboard and the dome camera. PTZ-CON TA connects 485+, TB connects 485-.
- ② shows the connection between the paralleled connected keyboard and DVR/NVR. DVR-CON: TA connects TA and TB connects TB.
- ④ shows the connection between the keyboard and DVR/NVR. DVR-CON1 TA connects D+ of KB and DVR-CON1 TB connects D- of KB.

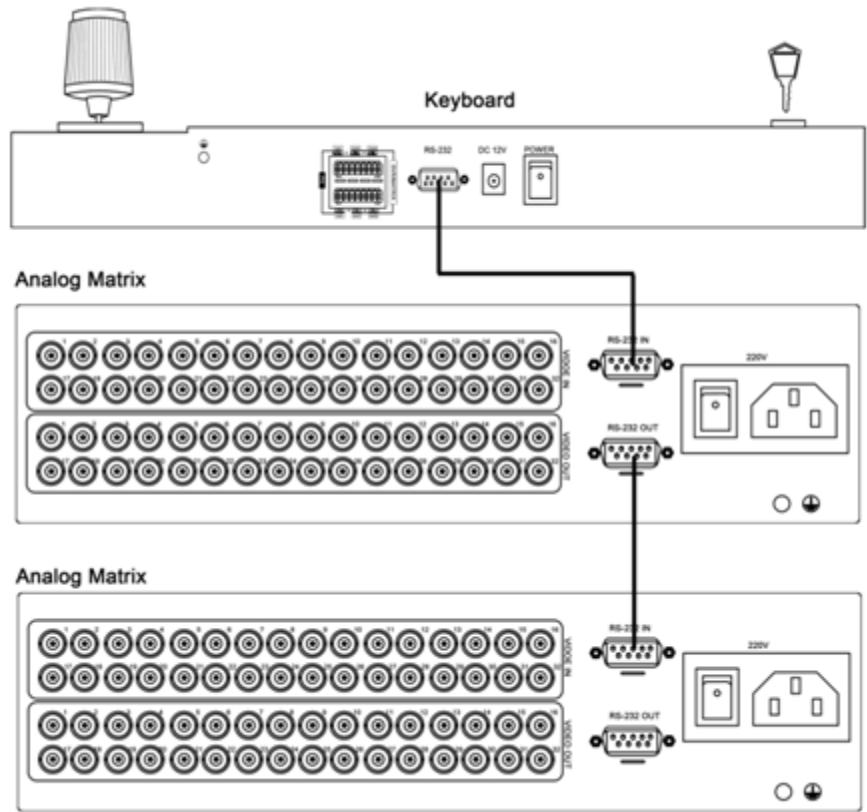
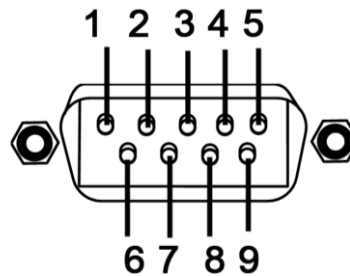

Figure 2-6 Connection between the keyboard and the analog matrix

The RS-232 interface of the PTZKB835 keyboard uses the DB9 interface. And the definition of pins of DB9 interface is written in the table below.

No.	Name	Function
1	DCD	--
2	RXD	Receiving Data
3	TXD	Transmitting Data
4	DTR	--
5	GND	Grounding
6	DSR	--
7	RTS	--
8	CTS	--
9	RI	--



The PTZKB835 keyboard uses RS-232 interface, the RS-232 interface connects the keyboard control interface on the analog matrix. The above figure shows the connection between keyboard and the analog matrix via RS-232 interface.

When connecting to more than one analog matrix, the analog matrix connected in parallel, showing in the above figure.

**Note:**

When controlling more than one analog matrix, the protocol is the ZT-1.0. Otherwise the cascading matrix cannot be controlled.

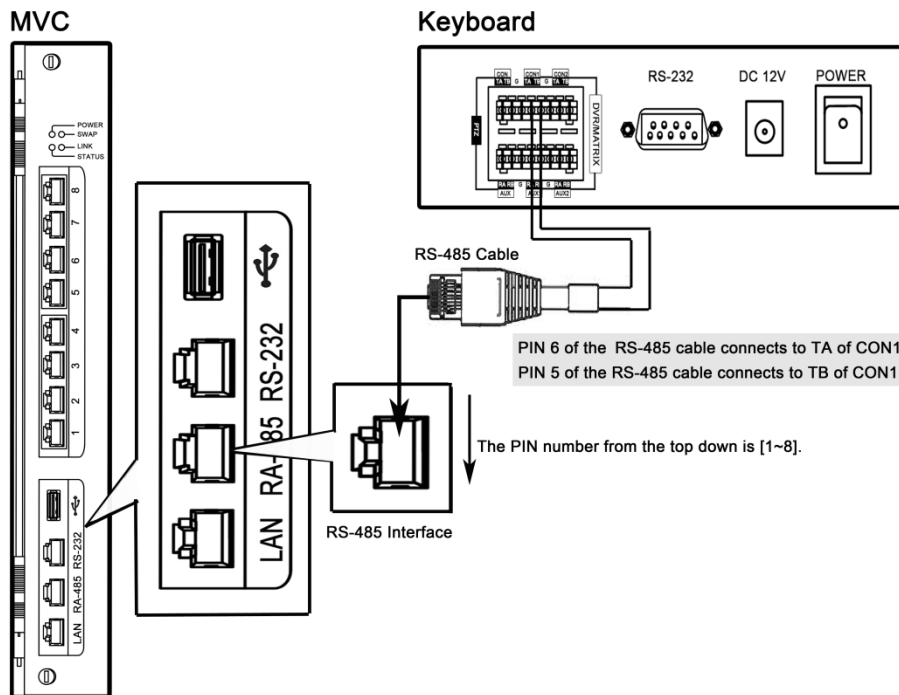

**Figure 2-7 Connection between the keyboard and the VMS**

The PTZKB835 keyboard controls the VMS, and to control it, you need to configure the VMS with the cascading configuration tool. Please refer to the manual of the VMS.

The DVR-CON TA connects the sixth pin of RS-485 interface on the VMS side, and the DVR-CON TB connects the fifth pin of RS-485 interface on the VMS side.

# Chapter 3 Keyboard Operation

## 3.1 Controlling DVR by Keyboard

### Setting the Keyboard Parameters to Control DVR

Once the keyboard is connected to the DVR, it can be used just as the front panel of the DVR. The joystick can move the cursor.

**Before you start:**

Check the connection between the DVR and the Keyboard.

TA and TB of CON1 on the keyboard connect to D+ and D- of the DVR. The following figure shows the simplest way of connection between a DVR and keyboard.

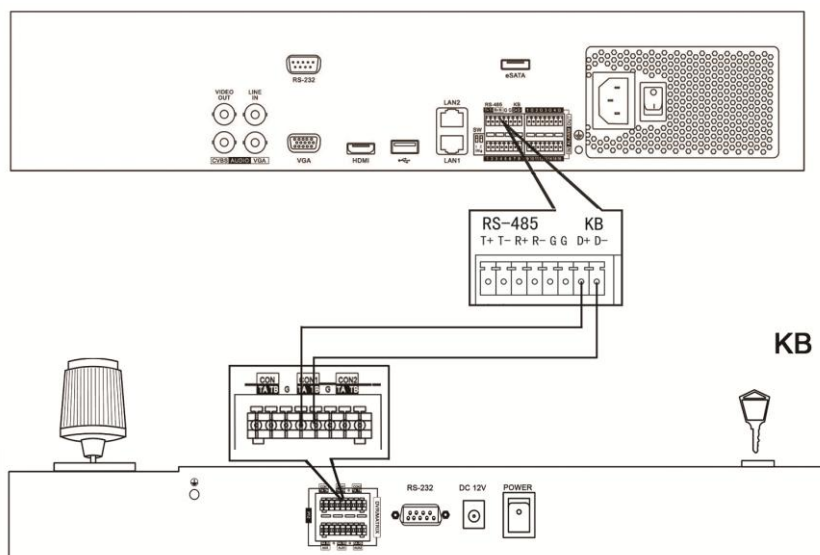

Figure 3-1 A Simple Connection between Keyboard and DVR

**Steps:**

1. On the keyboard, turn the key to the MENU item, and press the Mode button to select the DVR as the controlled device.

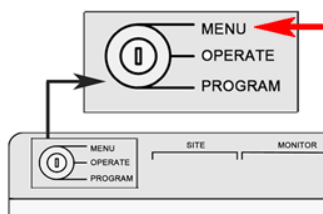

Figure 3-2 Turn the key to MENU

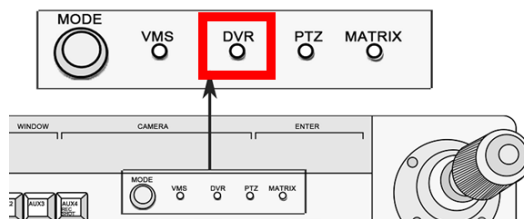

Figure 3-3 Choose MODE as DVR

2. Press the numeric button and press SITE to connect the DVR.

**Note:** The keyboard identifies the DVR by **SITE** value, and the **SITE** value must be exactly the same with the device number. E.g. the device number is 1, press the numeric button 1 and press **SITE** button again.

The keyboard only connects the DVR with device number ranging from 1 to 255.

3. You can move the joystick up and down to choose value and move the joystick left and right to switch the parameter to configure. The RS-485 parameters should be exactly the same with those of the DVR you controlled. The parameters include the baud rate, data bit, stop bit, and parity.

*By default, the baud rate is 9600, the data bit is 8, the stop bit is 1 and the parity is none.*

4. When the LED screen shows COPYALL, you can move the joystick to choose YES or NO.

If you choose **YES**, those parameters such as baud rate you set will be copied to all the DVRs you controlled by the keyboard.

5. Press Enter button to confirm your settings.

Now you can turn the key to the **OPERATE** item to control the DVR.

## Operating DVR by Keyboard

The keyboard, once connected, functions as the front panel of the DVR. You can refer to the front panel button description to see the function of each button. See the below information for complicated operation.

### Before you start:

To control DVR, make sure that the key is turned to the **OPERATE** mode.

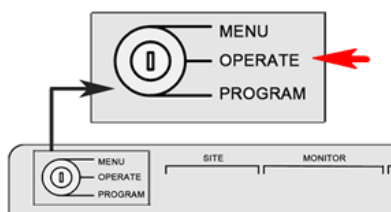

Figure 3-4 Turn the Key to OPERATE

- In live view mode, press numeric button to enter the corresponding one-channel live view. The **NEXT** and **LAST** button to choose the next or previous channel. When you open the menu, the **NEXT** and **LAST** button can be used to select the next or previous item.
- In the **OPERATE** mode the **PLAY/AUTO** button functions as the **PLAY/AUTO** button on the DVR front panel. Press it to play the record file within the 5 minutes of current channel. If you want to play back more record files, you should enter the main menu and choose Playback.
- **CLEAR** button functions as an ESC button.

**To call the preset/patrol/pattern:****Steps:**

6. Press **IRIS-/PTZ** button to enter the PTZ control interface of the DVR
7. Press the **PRESET/PATROL/PATTERN** button.
8. Press the numeric button.
9. Press **ENTER** button.



### 3.2 Controlling Dome Cameras by Keyboard

#### Setting the Keyboard Parameters to Control Dome Camera

**Before you start:**

Check the connection between the keyboard and dome camera. The **TA** and **TB** interfaces of CON of keyboard should be connected to the **RA** and **RB** interfaces of the dome camera respectively. The following figure shows the simplest way of connection between a dome camera and keyboard.

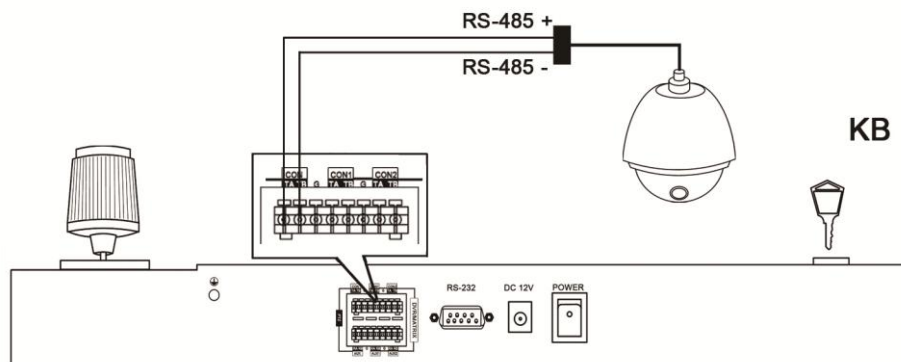

Figure 3-5 Dome and Keyboard Connection

**Steps:**

1. Turn the key to the **MENU** item, and press the **Mode** button to select **PTZ**.

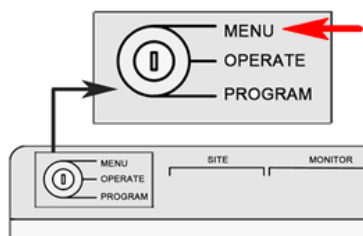

Figure 3-6 Turning the Key to MENU

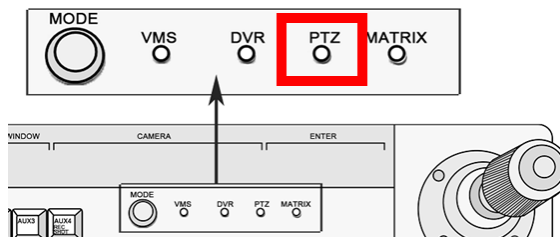

Figure 3-7 Choose Mode as PTZ

2. Enter the device number. E.g. the device number is 1, press the numeric button 1 and press **SITE** button again.  
**Note:** The keyboard identifies the dome camera by **SITE** value, and the **SITE** value must be exactly the same with the dome camera No..
3. Use the joystick to set the RS485 parameters.

The parameters include the protocol, baud rate, data bit, stop bit, and parity.

4. When the LED screen shows **COPYALL**, you can choose **YES** or **NO**.  
When you choose **YES**, the parameters you just set will be copied to other dome cameras connected.
5. Press **Enter** button to confirm your settings.
6. Turn the key to the **OPERATE** item to control the dome camera.

## Dome Camera Control Operation

The keyboard mainly controls the PTZ function of the dome camera. The PTZ function of the dome camera is realized by the compound operation of the joystick and the PTZ buttons.

- To call the preset, switch to the **OPERATE** mode, press PTZ button to enter PTZ control mode and press the numeric button and then press the preset button.
- **Note:** Call preset No. 95 to open the menu of the dome camera.
- To call patrol, switch to the **OPERATE** mode, press the numeric button and then press the patrol button;
- To call pattern, switch to the **OPERATE** mode, press the numeric button and then press the pattern button.

To set preset, patrol and pattern for the dome camera, you turn the key to the **PROGRAM** mode

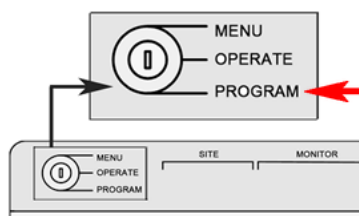

Figure 3-8 Turn the Key to PROGRAM

### Setting the preset

Press the numeric button and then press the preset button.

And the LED screen returns PRESET DONE, indicating that the preset is set.

### Setting the patrol:

**Note:** the patrol is a group of presets.

#### Steps:

1. In the **PROGRAM** mode. Press the numeric button and press the **PATROL** button.  
And then you can see the LED screen shows **PATROL SET**.
2. Press numeric button and press **Enter** button to choose the preset for the patrol.
3. Press the numeric button again and press **Enter** button again to set the patrol time.
4. Press the numeric button and press **Enter** button to set the patrol speed.
5. Press the **PATROL** button to finish the setting.

And the LED screen returns **PATROL DONE**, indicating that the patrol is set.

### Setting the pattern:

#### Steps:

1. Switch to the **PROGRAM** mode.
2. Press the numeric button and press the pattern button.
3. Use the joystick and **ZOOM+/-** button to control the PTZ and record the PTZ movement.
4. Press the **PATTERN** button again to set the pattern.

## 3.3 Controlling the VMS by Keyboard

### Setting the Keyboard Parameters to Control VMS

There is no RS485 interface for the VMS, you can use the RS-485-to-RS-232 converter to connect the VMS.

1. Turn the key to the **MENU** item, and press the **Mode** button to select the **Matrix** as the controlled device.
2. Press the **SITE** button to set the device identifier.

**Note:** The keyboard identifies the controlled device by the device address. You can set the **SITE** value to identify the device, and the **SITE** value must be exactly the same with the VMS address.

3. Enter the number. E.g. the device address is 1, press the numeric button 1 and press **SITE** button again.
4. Use the joystick to set the RS485 parameters.  
The parameters include the baud rate, data bit, stop bit, and parity.
5. When the LED screen shows **COPYALL**, you can use the joystick to choose **YES** or **NO**.
6. Press **Enter** button to confirm your settings.
7. Turn the key to the **OPERATE** item to control the VMS.

### VMS Control Operation

**Note:**

When using PTZKB835 to control the VMS, the parameters of the keyboard should be consistent to that of the VMS software and the VMS should be configured by the cascade configuration tools. For the detailed information of the configuration, refer to the user manual of the VMS. And since there is no RS-485 interface for VMS, you need to choose the RS-485-to-RS-232 interface as RS-485. The monitor in this chapter refers to the single monitor without montaging. Sub-screen refers to the small screens in single monitor.

#### Complicated Operation:

- Press the numeric button and then press the **MON** button to select the video output monitor.
- Press the numeric button and then press **CAM** button to choose video input channel.
- Press the numeric button and press **MULT** button to set the sub-screen. Press the numeric button and the **WIN** button to choose the sub-screen.

**Example:**

To set 4 sub-screens to the monitor 1 and display the video from camera 1 to the second window:

**Steps:**

1. Press numeric button 1 and press **MON** button.
2. Press numeric button 4 and press **MULT** button.
3. Press numeric button 2 and press **WIN** button.
4. Press numeric button 1 and press **CAM** button.

The monitor group and the camera group refer to the video output group and video input group respectively. When displaying the video from one camera group on one monitor, the cycle play function can be enabled. **HOLD** button can stop the cycle play and the **RUN** button can start or go on the cycle play. **NEXT** and **LAST** button can be used to switch to the next group or last group respectively.

**Example:**

To display the camera group 2 on the monitor 1 to cycle play and then stop cycle play and then go on the cycle play, and then switch to the camera group 1.

**Steps:**

1. Press numeric button 1 and press MON.
  2. Press numeric button 2 and press CAM-G button.
  3. Press **HOLD** button.
  4. Press **RUN** button.
  5. Press **LAST** button.
- To set the preset, turn the key to the **PROGRAM** mode, press the numeric button and press **CAM** button to choose camera. Press numeric button and press preset button the set preset.
  - To call the preset, switch to the **OPERATE** mode and press the numeric button and press **CAM** button to choose the camera. Press the numeric button and press preset button to call the preset.

**Setting the patrol:****Steps:**

1. Turn the key to **PROGRAM** mode, press the numeric and press **CAM** button to choose camera.
2. Press the numeric button and press **patrol** button to choose patrol to set.
3. Press the numeric button and **ENTER** button to call the preset you want to add to the patrol.
4. Press the numeric button and the **ENTER** button to set the interval for patrol.
5. Press the numeric button and **ENTER** button to set patrol speed.
6. Press **patrol** button again to finish your setting.

**Calling the patrol:****Steps:**

1. Turn the key to the **OPERATE** mode, press the numeric button and press **CAM** button to choose camera.
2. Press the numeric button and press **patrol** button to call the patrol.

**Setting the pattern,****Steps:**

1. Switch to the **PROGRAM** mode, and press the numeric button and press the **CAM** button to choose camera.
2. Press the numeric button and press the **pattern** button
3. Use the joystick to control the PTZ to record the PTZ movement.
4. Press the **pattern** button again to set the pattern.
5. To call the pattern, switch to the **OPERATE** mode, press the numeric button and press **CAM** button to choose camera.
6. Press the numeric button and press pattern to call the pattern.

## 3.4 Controlling the Analog Matrix by Keyboard

### Setting the Keyboard Parameters to Control Analog Matrix

The RS-232 communication is used when the PTZKB835 keyboard is controlling the analog matrix system. And the following parameters must be correctly configured for the RS-232 port: protocol, baud rate, data bit, stop bit and parity. ZT-1.0, ZT-2.0, EXTRON and CREATOR protocols are supported by the keyboard.

Turn the key to **MENU**; press the **SITE** button to select the address for analog matrix to be configured; and set the RS-232 parameters.

#### To set the RS-232 parameters:

##### Steps:

1. Move the joystick left/right to view selections.
2. Move the joystick up/down to select a parameter.
3. Move the joystick up/down to select YES in the COPYALL selection if you want to copy the settings to all the other devices. The default setting is NO.
4. Turn the key to Operate to operate the device remotely.

### Analog Matrix Controlling Operation

#### Main Operation:

- Use the **SITE** button to choose the analog matrix by its address.
- To display the video from a camera to a certain monitor.  
In the **OPERATE** mode, press the numeric button and then press the **MON** button to choose the video output monitor.  
Press the numeric button and press **CAM** button.
- Use the **NEXT** button and the **LAST** button to realize the switch of the video input.
- Use **CLEAR** button to delete the number you input or exit the operation.

## Appendix 1: Specification

<b>Model</b>	<b>PTZKB835</b>
Joystick	Four-Axis
Serial Port	RS485 and RS232
Working Temperature	-10°C- +55°C
Working Humidity	10%-90%
Power Supply	12VDC
Power Consumption	≤10W
Dimension (W×D×H)	434×163×43mm
Weight	≤1.25Kg

**First Choice for Security Professionals**