

## CMIP7553W5-SZ8 5MP 5-Lens PTRZ Network Camera

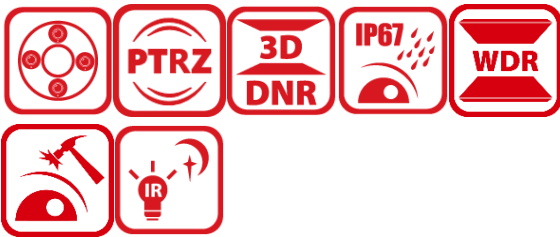

- 4 adjustable lenses in one camera cover up to 360° field of view, ensuring no blind area monitoring and the monitoring tilt angle can be adjusted
- Each lens up to 5 MP, capturing clear images, and more details can be displayed on video wall
- Clear imaging against strong back light due to 120 dB true WDR technology
- Water and dust resistant (IP67) and vandal proof (IK10)
- Human and vehicle target classification based on deep learning for up to 4 channels
- Unique PTRZ capability for efficient installation
- Audio and alarm interface available

## ▪ Specification

Camera	
Image Sensor	Varifocal: 1/2.4" Progressive Scan CMOS; Fixed: 1/2.5" Progressive Scan CMOS
Max. Resolution	2560 × 1920
Min. Illumination	Color: 0.005 Lux @ (F1.2, AGC ON),B/W: 0.002 Lux @ (F1.2, AGC ON),B/W: 0 Lux with IR
Shutter Time	1 s to 1/100,000 s
Day & Night	IR cut filter
Angle Adjustment	Pan: 0° to 350°,tilt: 0° to 90°,rotate: -90° to 90°
Lens	
Lens Type	Varifocal lens, motorized lens, 2.8 to 8 mm,Fixed focal lens, 2 mm
Focal Length & FOV	Varifocal :2.8 to 8 mm, horizontal FOV 96.5° to 48.9°, vertical FOV 69.9° to 36.5°, diagonal FOV 129° to 61.3° Fixed:2mm, horizontal FOV 71.68°, vertical FOV 71.68°, diagonal FOV 99.16°
Lens Mount	Ø14
Focus	Varifocal: Semi-auto,Manual
Aperture	Varifocal: F1.9; Fixed: F2.25
Illuminator	
Supplement Light Type	IR
Supplement Light Range	Up to 30 m
IR Wavelength	850 nm
Video	
Main Stream	Channel 1,2,3,4: 50 Hz: 25 fps (2560× 1920, 2048× 1536, 1920 × 1080, 1280 × 720) 60 Hz: 30 fps (2560× 1920, 2048× 1536, 1920 × 1080, 1280 × 720) Channel 5: 50 Hz: 25 fps (1440× 1440) 60 Hz: 30 fps (1440× 1440)
Sub-Stream	Channel 1,2,3,4: 50 Hz: 25 fps (704 × 576, 640 × 480) 60 Hz: 30 fps (704 × 480, 640 × 480) Channel 5: 50 Hz: 25 fps (576× 576, 480× 480) 60 Hz: 30 fps (576× 576, 480× 480)
Third Stream	Channel 1,2,3,4: 50 Hz: 25 fps (1920 × 1080, 1280 × 720, 704 × 576, 640 × 480) 60 Hz: 30 fps (1920 × 1080, 1280 × 720, 704 × 576, 640 × 480)
Video Compression	Main stream: H.265+/H.265/H.264+/H.264, Sub-stream: H.265/H.264/MJPEG, Third stream: H.265/H.264
Video Bit Rate	32 Kbps to 8 Mbps
H.264 Type	Baseline Profile,Main Profile,High Profile
H.265 Type	Main Profile
Scalable Video Coding (SVC)	H.264 and H.265 encoding
Region of Interest (ROI)	4 fixed regions for each stream

Target Cropping	Yes
<b>Audio</b>	
Audio Compression	G.711/G.722.1/G.726/MP2L2/PCM/MP3/AAC-LC
Audio Bit Rate	64 Kbps (G.711ulaw/G.711alaw)/16 Kbps (G.722.1)/16 Kbps (G.726)/32 to 192 Kbps (MP2L2)/8 to 320 Kbps (MP3)/16 to 64 Kbps (AAC-LC)
Audio Sampling Rate	8 kHz/16 kHz/32 kHz/48 kHz
Environment Noise Filtering	Yes
<b>Network</b>	
Protocols	TCP/IP, ICMP, HTTP, HTTPS, FTP, DHCP, DNS, DDNS, RTP, RTSP, RTCP, PPPoE, NTP, UPnP, SMTP, SNMP, IGMP, 802.1X, QoS, IPv4, IPv6, UDP, Bonjour, WebSocket, WebSockets, SSL/TLS
Simultaneous Live View	Up to 20 channels
API	Open Network Video Interface (Profile S, Profile G, Profile T),ISAPI,SDK,ISUP
User/Host	Up to 32 users 3 user levels: administrator, operator, and user
Security	Password protection, complicated password, HTTPS encryption, 802.1X authentication (EAP-MD5), watermark, IP address filter, basic and digest authentication for HTTP/HTTPS, WSSE and digest authentication for Open Network Video Interface
Network Storage	NAS (NFS, SMB/CIFS),Auto Network Replenishment (ANR), Together with memory card, memory card encryption and health detection are supported.
Client	NVMS V3, X-VMS, LTS Connect
Web Browser	Plug-in required live view: IE 10, IE 11, Plug-in free live view: Chrome 57.0+, Firefox 52.0+, Edge 89+, Safari 11+, Local service: Chrome 57.0+, Firefox 52.0+, Edge 89+
<b>Image</b>	
Image Settings	Rotate mode,saturation,brightness,contrast,sharpness,AGC,white balance,adjustable by client software or web browser
Day/Night Switch	Day,Night,Auto,Schedule,Alarm Trigger
Wide Dynamic Range (WDR)	120 dB
SNR	≥ 52 dB
Image Stabilization	EIS
Image Enhancement	BLC,HLC,3D DNR,Defog
Privacy Mask	8 programmable polygon privacy masks
Picture Overlay	LOGO picture can be overlaid on video with 128 × 128 24 bit bmp format.
<b>Interface</b>	
Ethernet Interface	1 RJ45 10 M/100 M/1000 M self-adaptive Ethernet port
On-Board Storage	Built-in memory card slot, support microSD/microSDHC/microSDXC card, up to 1 TB
Audio	1 input (line in), 3.5 mm connector, max. input amplitude: 3.3 Vpp, input impedance: 4.7 KΩ, interface type: non-equilibrium, 1 output (line out), 3.5 mm connector, max. output amplitude: 3.3 Vpp, output impedance: 100 Ω, interface type: non-equilibrium
Alarm	2 inputs, 2 outputs (max. 24 VDC, 1 A)
RS-485	1 RS-485 (Half duplex, Pelco-P, Pelco-D, self-adaptive)
Reset Key	Yes

<b>Event</b>	
Basic Event	Motion detection,video tampering alarm,network disconnected,IP address conflict,illegal login,HDD full,HDD error
Smart Event	Line crossing detection, intrusion detection, region entrance detection, region exiting detection (support alarm triggered by specified target types (human and vehicle)),scene change detection, unattended baggage detection,object removal detection
Linkage	Upload to FTP/NAS/memory card,notify surveillance center,send email,trigger alarm output,trigger recording,trigger capture
<b>Deep Learning Function</b>	
Perimeter Protection	Line crossing, intrusion, region entrance, region exiting Support alarm triggering by specified target types (human and vehicle)
<b>General</b>	
Power	12 VDC ± 20%, 1.8 A, max. 21.6 W, PoE: IEEE 802.3at, Type 2, Class 4, 42.5 V to 57 V, 0.58 A to 0.43 A, max. 25 W
Dimension	Ø290 mm × 148 mm (Ø11.42" × 5.8")
Package Dimension	453 mm × 393 mm × 385 mm (17.8" × 15.47" × 15.16")
Weight	Approx. 4.7 kg (10.36 lb.)
With Package Weight	Approx. 8.0 kg (17.63 lb.)
Storage Conditions	-40 °C to 60 °C (-40 °F to 140 °F). Humidity 95% or less (non-condensing)
Startup and Operating Conditions	-40 °C to 60 °C (-40 °F to 140 °F). Humidity 95% or less (non-condensing)
Language	33 languages: English, Russian, Estonian, Bulgarian, Hungarian, Greek, German, Italian, Czech, Slovak, French, Polish, Dutch, Portuguese, Spanish, Romanian, Danish, Swedish, Norwegian, Finnish, Croatian, Slovenian, Serbian, Turkish, Korean, Traditional Chinese, Thai, Vietnamese, Japanese, Latvian, Lithuanian, Portuguese (Brazil), Ukrainian
General Function	Heartbeat,flash log,password reset via email,pixel counter,password protection,one-key reset,anti-banding
<b>Approval</b>	
Protection	IP67: IEC 60529-2013,IK10: IEC 62262:2002



### ▪ DORI

The DORI (detect, observe, recognize, identify) distance gives the general idea of the camera ability to distinguish persons or objects within its field of view. It is calculated based on the camera sensor specification and the criteria given by EN 62676-4: 2015.



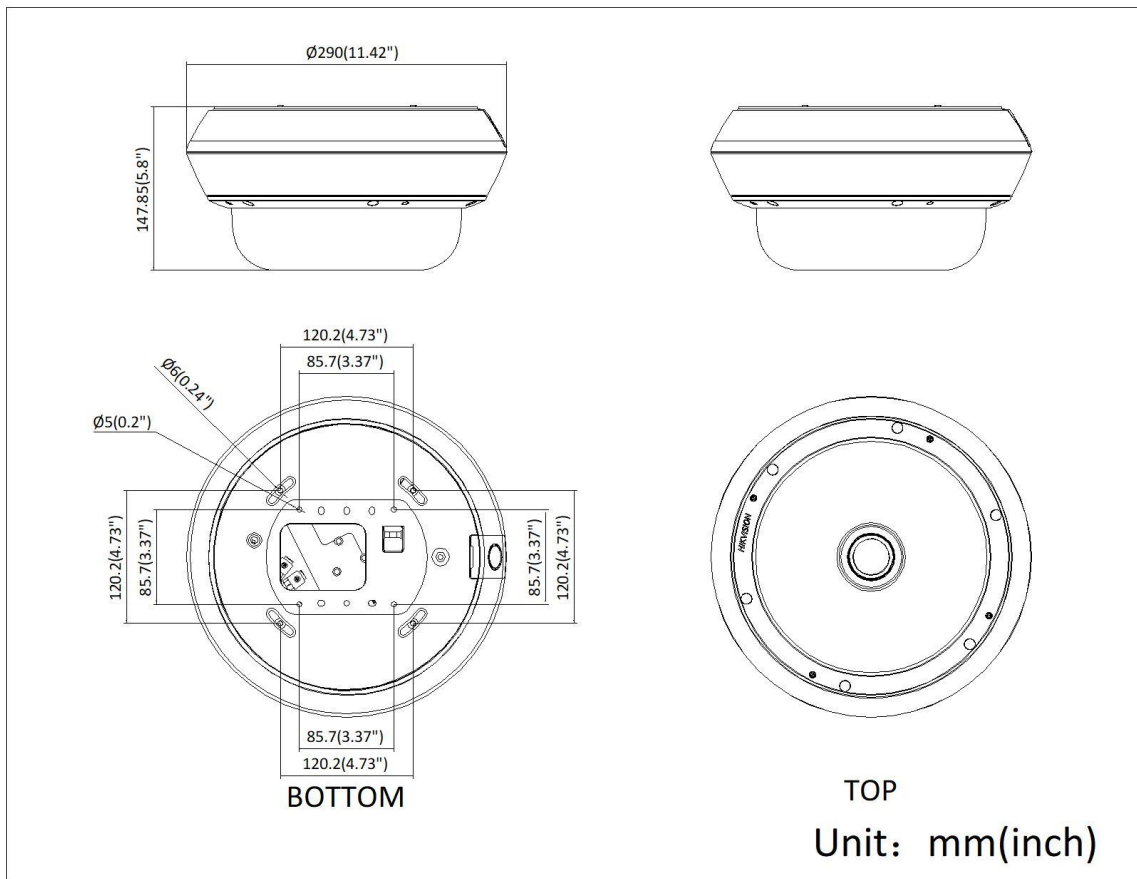

DORI	Detect	Observe	Recognize	Identify
Distance (Wide)	63.7 m	25.3 m	12.7 m	6.4 m
Distance (Tele)	120.5 m	47.8 m	24.1 m	12.1 m

### ▪ Dimension



▪ **Accessory**

▪ **Optional**

Wall Mount	LTB751-20 Pendant Mount	LTB751 Pendant Mount	LTB378 Pole mount	LTB742 Wall mount
				
<b>LTB397 Corner mount</b>				
