

C313X

Quick Guide

Unpacking

Please make sure the package contains the following items:



Screw fixing seat x 2

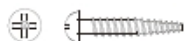

ST4X20 screw x 2



M4X30 screw x 2



11 Pin cable x 1



Wall bracket x 1



10 Pin cable x 1

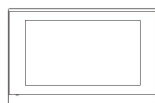

C313X x 1

C313X

Product Overview

Front Panel

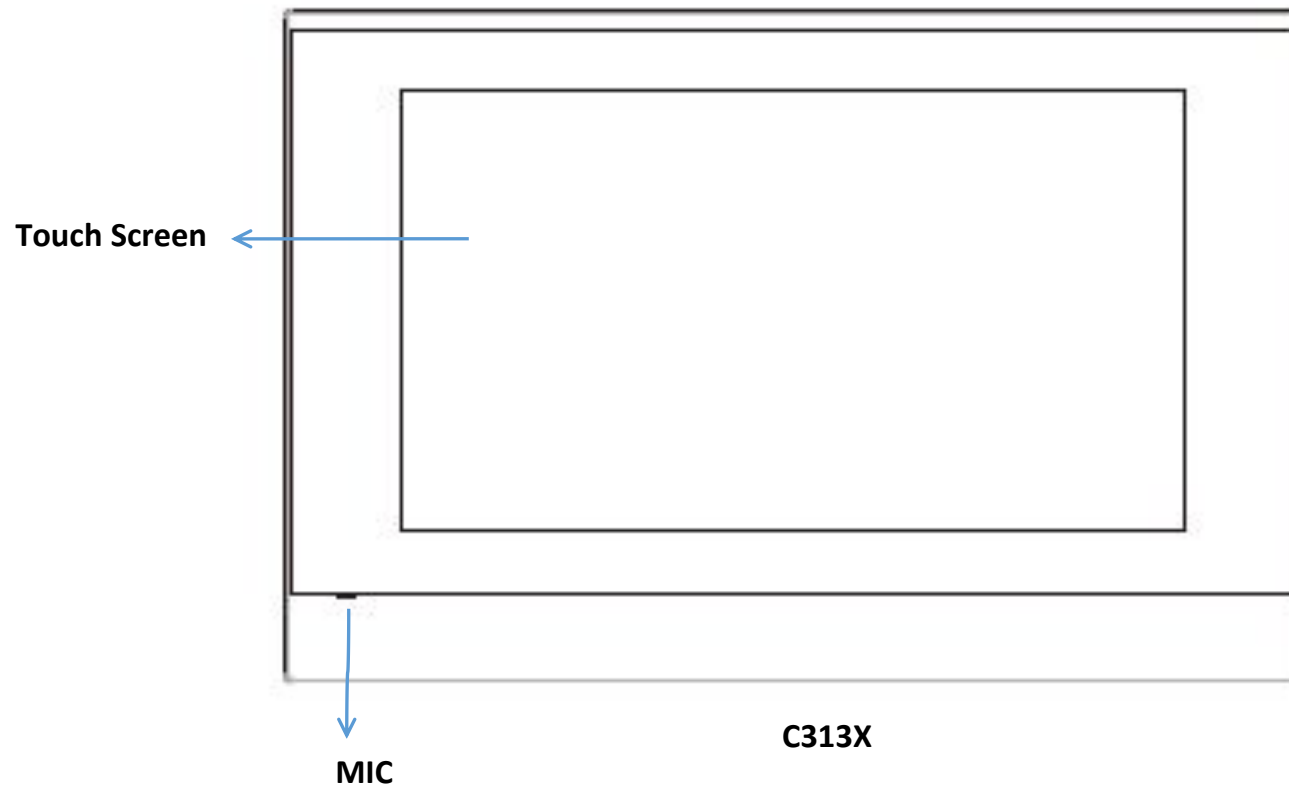

C313X

Rear Panel

Loudspeaker

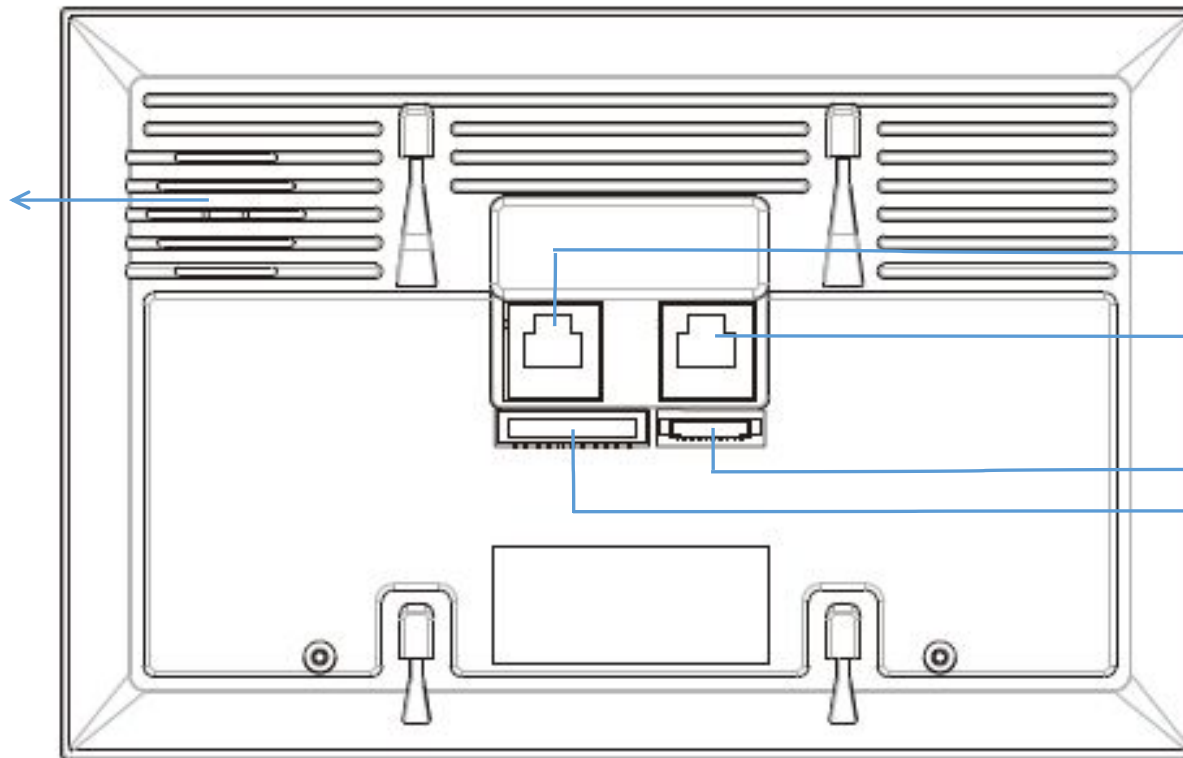

Network Interface (Power in)

RJ45 Interface

10 Pin Terminals

11 Pin Terminals

C313X

Installation

Without 86 embedded box in the wall

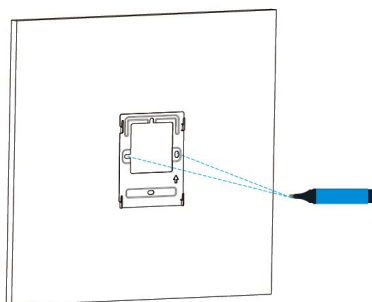

Mark two fixation holes through wall bracket on the wall, the distance between which is 60mm. Make sure the all cables can be passed from the middle of wall bracket.

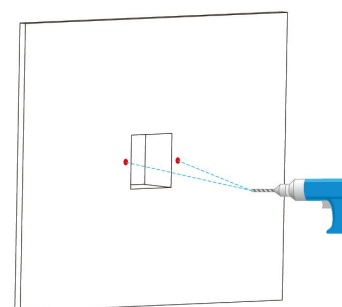

Take down the bracket, then using a 5mm hand drill to make the two fixation holes on the wall you marked before.

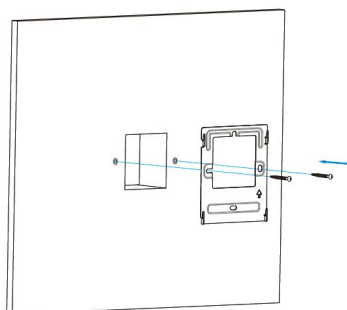

Use two ST4X20 screws to fix the wall bracket on the wall.

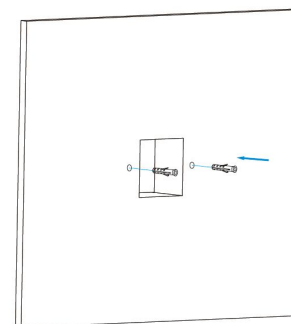

Once the fixation holes are made, insert the two screw fixing seats provided.

C313X

With 86 embedded box in the wall

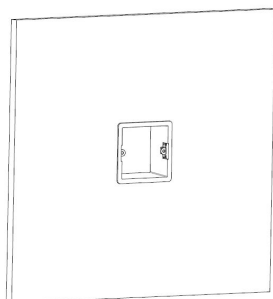

Make sure all cables in the 86 embedded box.

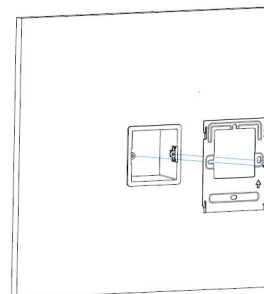

Fix the wall bracket on the 86 embedded box with two M4X30 screws.

Device Mounting

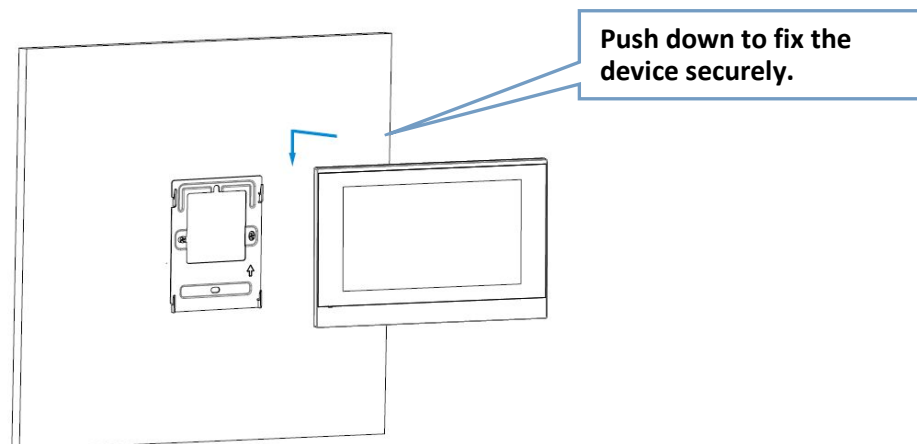



C313X

Configuration



1. After setting up network and power, press **Status** icon to check IP address (DHCP by default).
2. Launch web browser and type in the IP address to access web interface, login with username and password.(admin by default).
3. Register the device with your SIP account.(please refer to user manual for more information).

Operation

Make a call

Press Intercom key  , enter the callee's number or room address , then choose Audio  or Video  mode to call out.

Receive a call

When receiving a video call, users can choose Audio  or Video  mode to answer. However, if there is an audio call, users can only press Audio  mode to pick up.

C313X

Unlock

During the talk, press the Open Door key  in talking interface to unlock the door.

Monitor

Press Monitor key  to receive the video from indoor IPC or community IPC any time.

SOS

Press SOS key  in case of an emergency.